



Juno Wafer™ LED Downlight Series

4", 6" & 8" LED Ultra-Thin Wafer Switchable Downlight
5CCT Switchable White Downlight

WF4/WF6/WF8 SWW5 Series



Brushed Nickel



Oil Rubbed Bronze



Matte Black



Dimensions

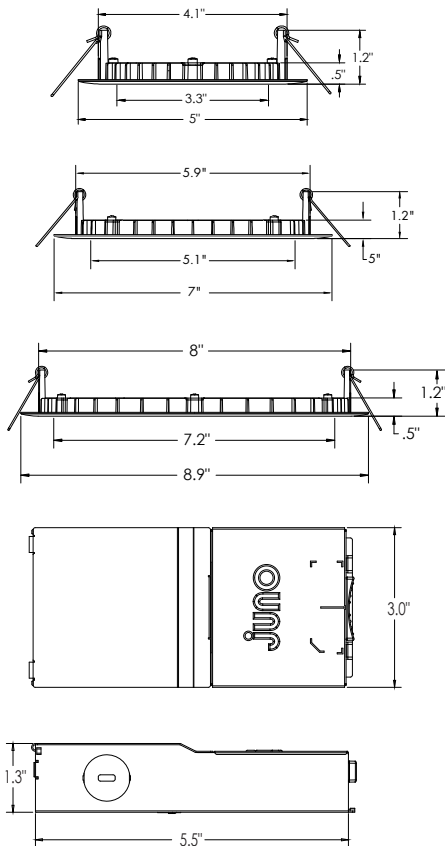

Project:
Fixture Type:
Location:
Contact/Phone:

Product Features

The 4", 6" & 8" round smooth with 5CCT Switchable White technology provide high-quality light output and efficiency featuring a switch for easy color temperature adjustment to choose between 2700K, 3000K, 3500K, 4000K, or 5000K - while eliminating the need for recessed housings.

- Round smooth lens trim designed to distribute precise even illumination for general purpose areas
- Canless - no can required; equals easy to install and less labor
- 5 selectable color temperatures to choose with a switch ranging from warm (2700K) to daylight (5000K) allowing customization for endless applications

Applications

- Residential and light commercial applications including multi-family, hospitality, assisted living, dormitories and other multi-level construction
- Shallow slim profile allows for easy remodel or new construction insulated and drop ceiling installations
- Wet rated and airtight: perfect for showers, bathrooms, and outdoor soffits

Performance

Delivered Lumens	670L (WF4), 970L (WF6) and 1640L (WF8) Nominal at 3000K
LED Color Temperature	Switchable White (27K, 30K, 35K, 40K, 50K) Default set at 3000K
CRI	90+
Voltage	Dedicated 120V
Dimming	Dimmable to 10% only with triac dimmers.

For a list of compatible dimmers see [JUNO-WAFERS-DIM](#)

Specifications

	WF4	WF6	WF8
Aperture:	3.3"	5.1"	7.2"
Ceiling Opening:	4.25"	6.25"	8.25"
Overlap Trim:	5"	7"	8.9"
Height:	1.2"	1.2"	1.2"



Juno Wafer™ LED Downlight Series

4", 6" & 8" LED Ultra-Thin Wafer Switchable Downlight
5CCT Switchable White Downlight



ORDERING INFORMATION

Downlight

Example: WF4 SWW5 90CRI MW M6

Series	Trim Style	Color Temperature	Rendering Index	Finish
WF4	4" Wafer-Thin LED Downlight	SWW5 Switchable White (2700K, 3000K, 3500K, 4000K, 5000K)	90CRI 90+ CRI	MW Matte White
WF6	6" Wafer-Thin LED Downlight			MB Matte Black
WF8¹	8" Wafer-Thin LED Downlight			BN Brushed Nickel
				ORB Oil Rubbed Bronze

1. WF8 only offered in a Matte White finish.

Accessories: Order as separate catalog number.

Series	Description
WF8643 PAN R6	Universal New Construction Pan, Retail Pack of 6
WF8643 PAN U	Universal New Construction Pan, Unit Pack
WF4 PAN R12	4" New construction pan, retail pack of 12
WF4GR MW JZ	4" Wafer Goof Ring 4.2" ID x 6.2" OD
WF6 PAN R12	6" New construction pan, retail pack of 12
WF6GR MW JZ	6" Wafer Goof Ring 6" ID x 8" OD
WF8GR MW JZ	8" Wafer Goof Ring 8.1" ID x 10.1 OD
WFJB U	Remodel Joist Bar
WFEXC6 SW3PIN FT4	3-Pin 6ft Cable
WFEXC10 SW3PIN FT4	3-Pin 10ft Cable
WFEXC20 SW3PIN FT4	3-Pin 20ft Cable



WF8643 UNIVERSAL
New Construction Pan



WF4 PAN
4" New Construction Pan



Remodel Joist Bar



WFEXC_
3-Pin Extension
Cable



WF6 PAN
6" New Construction Pan

*Goof rings are made of 22 gauge steel and painted white.

PERFORMANCE DATA

	WF4 SWW5	WF6 SWW5	WF8 SWW5
Input Voltage	120V	120V	120V
Input Power Typical	9W (+/-5%)	13W (+/-5%)	19W (+/-5%)
Frequency	60 Hz	60Hz	60Hz
EMI/RFI	FCC Title 47, Part 15 Class B (consumer)	FCC Title 47, Part 15 Class B (consumer)	FCC Title 47, Part 15 Class B (consumer)
Minimum Starting Temp	-40°F (-40°C)	-40°F (-40°C)	-40°F (-40°C)

Note: Actual performance may differ as a result of end-user environment and application. All values are design or typical values, measured under laboratory conditions at 25°C.

LIGHTING PERFORMANCE DATA DONNÉES SUR LE RENDEMENT DE L'ÉCLAIRAGE	
Light Appearance (CCT) Aspect de la lumière (CCT)	
2700K soft white blanc doux	665 lumens 74 lumens per watt
3000K warm white blanc chaud	670 lumens 74 lumens per watt
3500K neutral white blanc neutre	680 lumens 76 lumens per watt
4000K cool white blanc froid	685 lumens 76 lumens per watt
5000K daylight blanc neutre	690 lumens 76 lumens per watt
Watts	9
Color Accuracy (CRI) Précision des couleurs (CRI)	90

LIGHTING PERFORMANCE DATA DONNÉES SUR LE RENDEMENT DE L'ÉCLAIRAGE	
Light Appearance (CCT) Aspect de la lumière (CCT)	
2700K soft white blanc doux	955 lumens 73 lumens per watt
3000K warm white blanc chaud	970 lumens 74 lumens per watt
3500K neutral white blanc neutre	990 lumens 76 lumens per watt
4000K cool white blanc froid	1000 lumens 76 lumens per watt
5000K daylight blanc neutre	1005 lumens 77 lumens per watt
Watts	13
Color Accuracy (CRI) Précision des couleurs (CRI)	90

LIGHTING PERFORMANCE DATA DONNÉES SUR LE RENDEMENT DE L'ÉCLAIRAGE	
Light Appearance (CCT) Aspect de la lumière (CCT)	
2700K soft white blanc doux	1615 lumens 85 lumens per watt
3000K warm white blanc chaud	1640 lumens 86 lumens per watt
3500K neutral white blanc neutre	1670 lumens 88 lumens per watt
4000K cool white blanc froid	1690 lumens 89 lumens per watt
5000K daylight blanc neutre	1700 lumens 89 lumens per watt
Watts	19
Color Accuracy (CRI) Précision des couleurs (CRI)	90



Juno Wafer™ LED Downlight Series

4", 6" & 8" LED Ultra-Thin Wafer Switchable Downlight
5CCT Switchable White Downlight



Specifications

Housing

Polycarbonate injection molded outer frame, with steel back plate. Non-conductive dead-front trim design suitable for a wide range of applications and codes requiring a non-conductive lens • FT4 3-pin plenum rated cable connector to connect from module to remote driver box • Steel spring clip for easy installation. 4", 6" or 8" cut out template is provided to ensure a correct sized hole is cut into ceiling for proper installation of the trim. Size of hole should not exceed 4-1/4" for the WF4, 6-1/4" for the WF6 and 8-1/4" for the WF8 • Can be installed from 3/8" to 1 1/2" ceiling thickness • Can be removed from below the ceiling for service or replacement.

LED Light Engine

Switchable white color temperature from 2700K, 3000K, 3500K, 4000K, 5000K • 90 CRI minimum • Color accuracy within 4 step McAdams Ellipse at the end CCT (2700K and 5000K), within 6 step McAdams Ellipse in the middle CCT (3000K, 3500K, and 4000K) • Dimming 100% to 10% with most standard incandescent dimers (see list of approved dimmers).

Driver

Connect directly to 120V Class-2 (CAN ICES-005 (B) / NMB-005 (B)) LED driver • 120V 60 Hz constant current driver provides noise free operation • IC rated driver with convenience of a switch to choose between 5 selectable color temperature options ranging from 2700K (warm white), 3000K, 3500K, 4000K, or 5000K (daylight) • The isolated driver integrated inside steel remote box with four 7/8" knockouts with slots for pryout. Suitable for pulling wires with the 12 cubic-inch wiring compartment to accommodate up to (6) 14 gauge insulated conductor or (4) 12 gauge insulated conductors, making the Wafer LED Downlights much easier to wire in 2in/2out (plus ground) daisy-chain applications and contractor friendly • 2" plenum space required for the installation of the WF6 and WF8 driver boxes; 3" plenum space required for the installation of the WF4 driver box • Suitable for installation in t-grid and drop ceiling applications with universal new construction pan.

Optical System

Edge-lit LED technology uses light guided plate to distribute light • Polycarbonate lens provides even illumination throughout the space • Efficient system that can produce over 670 lumens while using 9W (WF4), 970 lumens while using 13W (WF6) and 1640 lumens while using 19W (WF8) • Replaces 65W incandescent (WF4), 75W incandescent (WF6) and 100W incandescent (WF8).

Life

Rated for 50,000 hours at 70% lumen maintenance.

Labels

CSA certified to US and Canadian safety standards • ENERGY STAR® certified product • Suitable for wet location, covered ceiling • Air-Loc certified in accordance with ASTM E283-2004 • NOM Certified • Can be used to comply with California Title 24 Part 6 High Efficacy LED light Source Requirements • U.S. Patent No. 10,681,784.

Testing

All reports are based on published industry procedures; field performance may differ from laboratory performance.

Warranty

3-year limited warranty. This is the only warranty provided and no other statements in this specification sheet create any warranty of any kind. All other express and implied warranties are disclaimed. Complete warranty terms located at: www.acuitybrands.com/support/warranty/terms-and-conditions

Note: Actual performance may differ as a result of end-user environment and application.

All values are design or typical values, measured under laboratory conditions at 25 °C.

Specifications subject to change without notice.



Juno Wafer™ LED Downlight Series

4", 6" & 8" LED Ultra-Thin Wafer Switchable Downlight
5CCT Switchable White Downlight



PHOTOMETRICS

Distribution Curve

Distribution Data

Output Data

Coefficient of Utilization

Illuminance Data at 30" Above Floor for a Single Luminaire

WF4 SWW5 90CRI 2700K Input Watts: 8.9, Delivered Lumens: 670, LPW: 75.3, S/MH: 1.09, Test No: ISF 202630P1

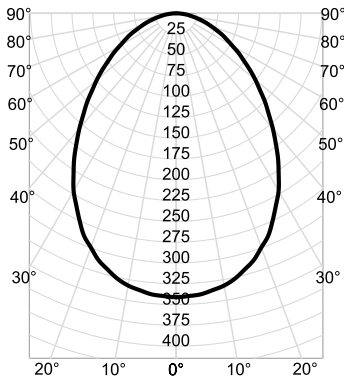

CP Summary				Zonal Lumen Summary				Coefficients of Utilization									Cone of Light			Luminance (cd/sq.m)	
0°	Zone	Lumens	% Fixture	pf pc	80%	20%	50%	70%	10%	50%	30%	10%	50%	30%	10%	Mounting Height	Initial FC Center Beam	Beam Diameter	Average Luminance		
0°	341	0° - 30°	243	36%	0	119	119	119	116	116	116	111	111	111	6.0	9.5	10.7	0°	42,950		
5°	339	0° - 40°	369	55%	1	106	102	98	104	100	97	99	96	94	8.0	5.3	14.2	45°	26,951		
15°	319	0° - 60°	568	85%	2	94	88	82	92	86	81	88	84	80	10.0	3.4	17.8	55°	21,820		
25°	275	0° - 90°	670	100%	3	84	76	70	82	75	70	79	73	68	12.0	2.4	21.3	65°	18,172		
35°	214	90° - 180°	0	0%	4	75	67	61	74	66	60	71	65	60	14.0	1.7	24.9	75°	14,836		
45°	151	0° - 180°	670	100%	5	68	60	53	67	59	53	65	58	53				85°	11,422		
55°	99				6	62	53	47	61	53	47	59	52	47							
65°	61				7	57	48	43	56	48	42	54	47	42							
75°	31				8	52	44	39	51	44	38	50	43	38							
85°	8				9	48	40	35	48	40	35	46	40	35							
90°	0				10	45	37	32	44	37	32	43	37	32							

Beam Angle: 83.2°
Field Angle: 147.3°

WF4 SWW5 90CRI 3000K Input Watts: 8.9, Delivered Lumens: 678, LPW: 76.2, S/MH: 1.09, Test No: ISF 202630P2

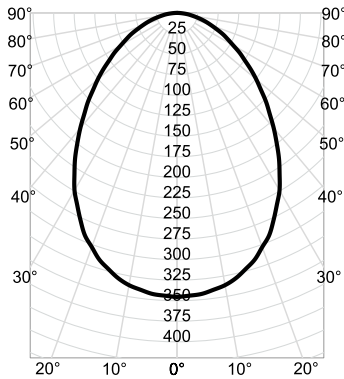

CP Summary				Zonal Lumen Summary				Coefficients of Utilization									Cone of Light			Luminance (cd/sq.m)	
0°	Zone	Lumens	% Fixture	pf pc	80%	20%	50%	70%	10%	50%	30%	10%	50%	30%	10%	Mounting Height	Initial FC Center Beam	Beam Diameter	Average Luminance		
0°	345	0° - 30°	246	36%	0	119	119	119	116	116	116	111	111	111	6.0	9.6	10.7	0°	43,464		
5°	343	0° - 40°	374	55%	1	106	102	98	104	100	97	99	96	94	8.0	5.4	14.2	45°	27,273		
15°	322	0° - 60°	575	85%	2	94	88	82	92	86	81	88	84	80	10.0	3.5	17.8	55°	22,081		
25°	278	0° - 90°	678	100%	3	84	76	70	82	75	70	79	73	68	12.0	2.4	21.3	65°	18,389		
35°	216	90° - 180°	0	0%	4	75	67	61	74	66	60	71	65	60	14.0	1.8	24.9	75°	15,014		
45°	153	0° - 180°	678	100%	5	68	60	53	67	59	53	65	58	53				85°	11,559		
55°	101				6	62	53	47	61	53	47	59	52	47							
65°	62				7	57	48	43	56	48	42	54	47	42							
75°	31				8	52	44	39	51	44	38	50	43	38							
85°	8				9	48	40	35	48	40	35	46	40	35							
90°	0				10	45	37	32	44	37	32	43	37	32							

Beam Angle: 83.2°
Field Angle: 147.3°

WF4 SWW5 90CRI 3500K Input Watts: 8.9, Delivered Lumens: 688, LPW: 77.3, S/MH: 1.09, Test No: ISF 202630P3

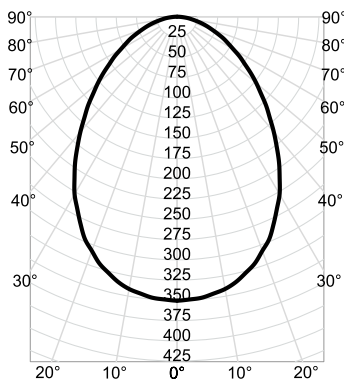

CP Summary				Zonal Lumen Summary				Coefficients of Utilization									Cone of Light			Luminance (cd/sq.m)	
0°	Zone	Lumens	% Fixture	pf pc	80%	20%	50%	70%	10%	50%	30%	10%	50%	30%	10%	Mounting Height	Initial FC Center Beam	Beam Diameter	Average Luminance		
0°	350	0° - 30°	249	36%	0	119	119	119	116	116	116	111	111	111	6.0	9.7	10.7	0°	44,106		
5°	348	0° - 40°	379	55%	1	106	102	98	104	100	97	99	96	94	8.0	5.5	14.2	45°	27,676		
15°	327	0° - 60°	583	85%	2	94	88	82	92	86	81	88	84	80	10.0	3.5	17.8	55°	22,407		
25°	282	0° - 90°	688	100%	3	84	76	70	82	75	70	79	73	68	12.0	2.4	21.3	65°	18,661		
35°	219	90° - 180°	0	0%	4	75	67	61	74	66	60	71	65	60	14.0	1.8	24.9	75°	15,235		
45°	156	0° - 180°	688	100%	5	68	60	53	67	59	53	65	58	53				85°	11,730		
55°	102				6	62	53	47	61	53	47	59	52	47							
65°	63				7	57	48	43	56	48	42	54	47	42							
75°	31				8	52	44	39	51	44	38	50	43	38							
85°	8				9	48	40	35	48	40	35	46	40	35							
90°	0				10	45	37	32	44	37	32	43	37	32							

Beam Angle: 83.2°
Field Angle: 147.3°



Juno Wafer™ LED Downlight Series

4", 6" & 8" LED Ultra-Thin Wafer Switchable Downlight
5CCT Switchable White Downlight



PHOTOMETRICS

Distribution Curve

Distribution Data

Output Data

Coefficient of Utilization

Illuminance Data at 30" Above Floor for a Single Luminaire

WF4 SWW5 90CRI 4000K Input Watts: 8.9, Delivered Lumens: 695, LPW: 78.1, S/MH: 1.09, Test No: ISF 202630P4

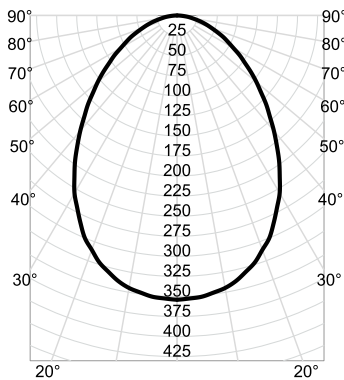

0°	CP Summary				Zonal Lumen Summary										Coefficients of Utilization										Cone of Light			Luminance (cd/sq.m)	
	Zone	Lumens	% Fixture	pw	80%		70%		50%		Mounting Height	Initial FC Center Beam	Beam Diameter	0°	45°	55°	65°	75°	85°										
					50%	30%	10%	50%	30%	10%										50%	30%	10%	Average Luminance						
0°	354	0° - 30°	252	36%	0	119	119	119	116	116	116	111	111	111	6.0	9.8	10.7	0°	44,555										
5°	352	0° - 40°	383	55%	1	106	102	98	104	100	97	99	96	94	8.0	5.5	14.2	45°	27,958										
15°	331	0° - 60°	589	85%	2	94	88	82	92	86	81	88	84	80	10.0	3.5	17.8	55°	22,635										
25°	285	0° - 90°	695	100%	3	84	76	70	82	75	70	79	73	68	12.0	2.5	21.3	65°	18,851										
35°	222	90° - 180°	0	0%	4	75	67	61	74	66	60	71	65	60	14.0	1.8	24.9	75°	15,391										
45°	157	0° - 180°	695	100%	5	68	60	53	67	59	53	65	58	53				85°	11,849										
55°	103				6	62	53	47	61	53	47	59	52	47	Beam Angle: 83.2°														
65°	63				7	57	48	43	56	48	42	54	47	42	Field Angle: 147.3°														
75°	32				8	52	44	39	51	44	38	50	43	38															
85°	8				9	48	40	35	48	40	35	46	40	35															
90°	0				10	45	37	32	44	37	32	43	37	32															

WF4 SWW5 90CRI 5000K Input Watts: 8.9, Delivered Lumens: 698, LPW: 78.4, S/MH: 1.09, Test No: ISF 202630P5

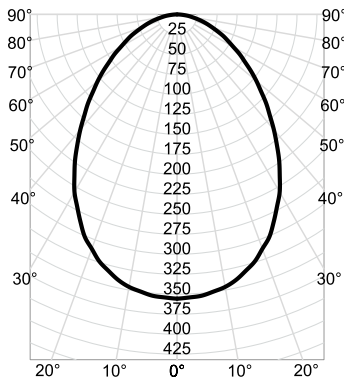

0°	CP Summary				Zonal Lumen Summary										Coefficients of Utilization										Cone of Light			Luminance (cd/sq.m)	
	Zone	Lumens	% Fixture	pw	80%		70%		50%		Mounting Height	Initial FC Center Beam	Beam Diameter	0°	45°	55°	65°	75°	85°										
					50%	30%	10%	50%	30%	10%										50%	30%	10%	Average Luminance						
0°	356	0° - 30°	253	36%	0	119	119	119	116	116	116	111	111	111	6.0	9.9	10.7	0°	44,748										
5°	353	0° - 40°	385	55%	1	106	102	98	104	100	97	99	96	94	8.0	5.6	14.2	45°	28,079										
15°	332	0° - 60°	592	85%	2	94	88	82	92	86	81	88	84	80	10.0	3.6	17.8	55°	22,733										
25°	286	0° - 90°	698	100%	3	84	76	70	82	75	70	79	73	68	12.0	2.5	21.3	65°	18,933										
35°	223	90° - 180°	0	0%	4	75	67	61	74	66	60	71	65	60	14.0	1.8	24.9	75°	15,457										
45°	158	0° - 180°	698	100%	5	68	60	53	67	59	53	65	58	53				85°	11,901										
55°	104				6	62	53	47	61	53	47	59	52	47	Beam Angle: 83.2°														
65°	64				7	57	48	43	56	48	42	54	47	42	Field Angle: 147.3°														
75°	32				8	52	44	39	51	44	38	50	43	38															
85°	8				9	48	40	35	48	40	35	46	40	35															
90°	0				10	45	37	32	44	37	32	43	37	32															



Juno Wafer™ LED Downlight Series

4", 6" & 8" LED Ultra-Thin Wafer Switchable Downlight
5CCT Switchable White Downlight



PHOTOMETRICS

Distribution Curve

Distribution Data

Output Data

Coefficient of Utilization

Illuminance Data at 30" Above Floor for a Single Luminaire

WF6 SWW5 90CRI 2700K Input Watts: 13.1, Delivered Lumens: 955, LPW: 72.9, S/MH: 1.09, Test No: ISF 202630P6

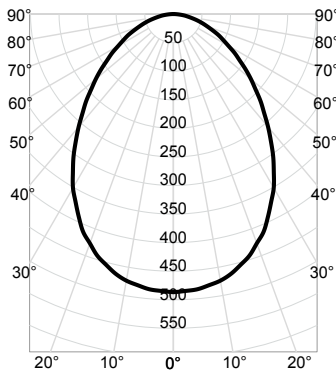

CP Summary	Zonal Lumen Summary				Coefficients of Utilization										Cone of Light			Luminance (cd/sq.m)		
					0°	Zone	Lumens	% Fixture	pf	pc	80%			20%			Mounting Height	Initial FC Center Beam	Beam Diameter	Average Luminance
											50%	30%	10%	50%	30%	10%				
0°	487	0° - 30°	346	36%	0	119	119	119	116	116	111	111	111	6.0	13.5	10.7	0°	61,247		
5°	483	0° - 40°	527	55%	1	106	102	98	104	100	97	99	96	8.0	7.6	14.2	45°	38,433		
15°	454	0° - 60°	810	85%	2	94	88	82	92	86	81	88	84	10.0	4.9	17.8	55°	31,115		
25°	392	0° - 90°	955	100%	3	84	76	70	82	75	70	79	73	12.0	3.4	21.3	65°	25,913		
35°	305	90° - 180°	0	0%	4	75	67	61	74	66	60	71	65	14.0	2.5	24.9	75°	21,157		
45°	216	0° - 180°	955	100%	5	68	60	53	67	59	53	65	58				85°	16,288		
55°	142				6	62	53	47	61	53	47	59	52							
65°	87				7	57	48	43	56	48	42	54	47							
75°	44				8	52	44	39	51	44	38	50	43							
85°	11				9	48	40	35	48	40	35	46	40							
90°	0				10	45	37	32	44	37	32	43	37							

Beam Angle: 83.2°
Field Angle: 147.3°

WF6 SWW5 90CRI 3000K Input Watts: 13.1, Delivered Lumens: 964, LPW: 73.6, S/MH: 1.09, Test No: ISF 202630P7

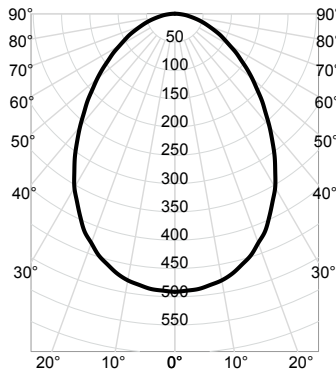

CP Summary	Zonal Lumen Summary				Coefficients of Utilization										Cone of Light			Luminance (cd/sq.m)		
					0°	Zone	Lumens	% Fixture	pf	pc	80%			20%			Mounting Height	Initial FC Center Beam	Beam Diameter	Average Luminance
											50%	30%	10%	50%	30%	10%				
0°	491	0° - 30°	350	36%	0	119	119	119	116	116	111	111	111	6.0	13.6	10.7	0°	61,825		
5°	488	0° - 40°	531	55%	1	106	102	98	104	100	97	99	96	8.0	7.7	14.2	45°	38,795		
15°	459	0° - 60°	817	85%	2	94	88	82	92	86	81	88	84	10.0	4.9	17.8	55°	31,409		
25°	395	0° - 90°	964	100%	3	84	76	70	82	75	70	79	73	12.0	3.4	21.3	65°	26,158		
35°	307	90° - 180°	0	0%	4	75	67	61	74	66	60	71	65	14.0	2.5	24.9	75°	21,356		
45°	218	0° - 180°	964	100%	5	68	60	53	67	59	53	65	58				85°	16,442		
55°	143				6	62	53	47	61	53	47	59	52							
65°	88				7	57	48	43	56	48	42	54	47							
75°	44				8	52	44	39	51	44	38	50	43							
85°	11				9	48	40	35	48	40	35	46	40							
90°	0				10	45	37	32	44	37	32	43	37							

Beam Angle: 83.2°
Field Angle: 147.3°

WF6 SWW5 90CRI 3500K Input Watts: 13.1, Delivered Lumens: 980, LPW: 74.8, S/MH: 1.09, Test No: ISF 202630P8

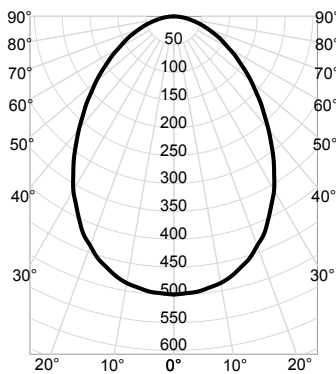

CP Summary	Zonal Lumen Summary				Coefficients of Utilization										Cone of Light			Luminance (cd/sq.m)		
					0°	Zone	Lumens	% Fixture	pf	pc	80%			20%			Mounting Height	Initial FC Center Beam	Beam Diameter	Average Luminance
											50%	30%	10%	50%	30%	10%				
0°	499	0° - 30°	355	36%	0	119	119	119	116	116	111	111	111	6.0	13.9	10.7	0°	62,852		
5°	496	0° - 40°	540	55%	1	106	102	98	104	100	97	99	96	8.0	7.8	14.2	45°	39,440		
15°	466	0° - 60°	831	85%	2	94	88	82	92	86	81	88	84	10.0	5.0	17.8	55°	31,930		
25°	402	0° - 90°	980	100%	3	84	76	70	82	75	70	79	73	12.0	3.5	21.3	65°	26,592		
35°	313	90° - 180°	0	0%	4	75	67	61	74	66	60	71	65	14.0	2.5	24.9	75°	21,711		
45°	222	0° - 180°	980	100%	5	68	60	53	67	59	53	65	58				85°	16,715		
55°	146				6	62	53	47	61	53	47	59	52							
65°	89				7	57	48	43	56	48	42	54	47							
75°	45				8	52	44	39	51	44	38	50	43							
85°	12				9	48	40	35	48	40	35	46	40							
90°	0				10	45	37	32	44	37	32	43	37							

Beam Angle: 83.2°
Field Angle: 147.3°



Juno Wafer™ LED Downlight Series

4", 6" & 8" LED Ultra-Thin Wafer Switchable Downlight
5CCT Switchable White Downlight



PHOTOMETRICS

Distribution Curve

Distribution Data

Output Data

Coefficient of Utilization

Illuminance Data at 30" Above Floor for a Single Luminaire

WF6 SWW5 90CRI 4000K Input Watts: 13.1, Delivered Lumens: 988, LPW: 75.4, S/MH: 1.09, Test No: ISF 202630P9

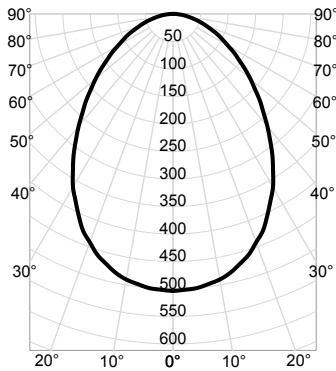

CP Summary		Zonal Lumen Summary		Coefficients of Utilization										Cone of Light			Luminance (cd/sq.m)	
0°	Zone	Lumens	% Fixture	pf	80%		20%		70%		50%		Mounting Height	Initial FC Center Beam	Beam Diameter	Average Luminance		
				pc	50%	30%	10%	50%	30%	10%	50%	30%					10%	
0°	504	0° - 30°	358	36%	0	119	119	119	116	116	116	111	111	111	6.0	14.0	10.7	0° 63,366
5°	500	0° - 40°	545	55%	1	106	102	98	104	100	97	99	96	94	8.0	7.9	14.2	45° 39,762
15°	470	0° - 60°	838	85%	2	94	88	82	92	86	81	88	84	80	10.0	5.0	17.8	55° 32,191
25°	405	0° - 90°	988	100%	3	84	76	70	82	75	70	79	73	68	12.0	3.5	21.3	65° 26,810
35°	315	90° - 180°	0	0%	4	75	67	61	74	66	60	71	65	60	14.0	2.6	24.9	75° 21,888
45°	223	0° - 180°	988	100%	5	68	60	53	67	59	53	65	58	53				85° 16,852
55°	147				6	62	53	47	61	53	47	59	52	47				
65°	90				7	57	48	43	56	48	42	54	47	42				
75°	45				8	52	44	39	51	44	38	50	43	38				
85°	12				9	48	40	35	48	40	35	46	40	35				
90°	0				10	45	37	32	44	37	32	43	37	32				

Beam Angle: 83.2°
Field Angle: 147.3°

WF6 SWW5 90CRI 5000K Input Watts: 13.1, Delivered Lumens: 989, LPW: 75.5, S/MH: 1.09, Test No: ISF 202630P10

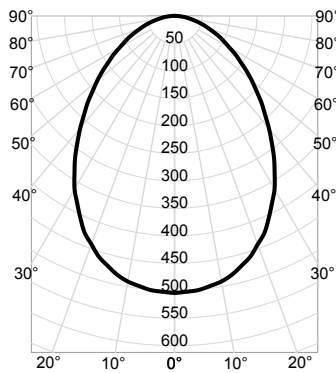

CP Summary		Zonal Lumen Summary		Coefficients of Utilization										Cone of Light			Luminance (cd/sq.m)	
0°	Zone	Lumens	% Fixture	pf	80%		20%		70%		50%		Mounting Height	Initial FC Center Beam	Beam Diameter	Average Luminance		
				pc	50%	30%	10%	50%	30%	10%	50%	30%					10%	
0°	504	0° - 30°	359	36%	0	119	119	119	116	116	116	111	111	111	6.0	14.0	10.7	0° 63,430
5°	501	0° - 40°	545	55%	1	106	102	98	104	100	97	99	96	94	8.0	7.9	14.2	45° 39,802
15°	471	0° - 60°	838	85%	2	94	88	82	92	86	81	88	84	80	10.0	5.0	17.8	55° 32,224
25°	406	0° - 90°	989	100%	3	84	76	70	82	75	70	79	73	68	12.0	3.5	21.3	65° 26,837
35°	315	90° - 180°	0	0%	4	75	67	61	74	66	60	71	65	60	14.0	2.6	24.9	75° 21,911
45°	224	0° - 180°	989	100%	5	68	60	53	67	59	53	65	58	53				85° 16,869
55°	147				6	62	53	47	61	53	47	59	52	47				
65°	90				7	57	48	43	56	48	42	54	47	42				
75°	45				8	52	44	39	51	44	38	50	43	38				
85°	12				9	48	40	35	48	40	35	46	40	35				
90°	0				10	45	37	32	44	37	32	43	37	32				

Beam Angle: 83.2°
Field Angle: 147.3°



Juno Wafer™ LED Downlight Series

4", 6" & 8" LED Ultra-Thin Wafer Switchable Downlight
5CCT Switchable White Downlight



PHOTOMETRICS

Distribution Curve Distribution Data Output Data Coefficient of Utilization Illuminance Data at 30" Above Floor for a Single Luminaire

WF8 SWW5 90CRI 2700K Input Watts: 19.7, Delivered Lumens: 1627, LPW: 82.6, S/MH: 1.09, Test No: ISF 202630P11

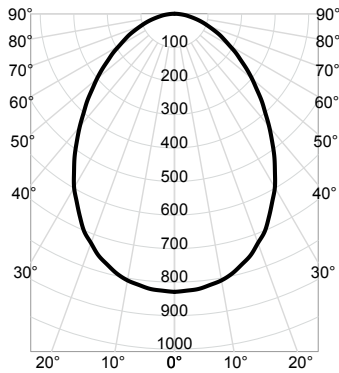

CP Summary	Zonal Lumen Summary				Coefficients of Utilization								Cone of Light			Luminance (cd/sq.m)	
	0°	Zone	Lumens	% Fixture	pf	80%		20%		70%		50%		Mounting Height	Initial FC Center Beam	Beam Diameter	Average Luminance
						pw	50%	30%	10%	50%	30%	10%	50%				
0°	829	0° - 30°	590	36%	0	119	119	119	116	116	116	111	111	6.0	23.0	10.7	0° 104,326
5°	823	0° - 40°	897	55%	1	106	102	98	104	100	97	99	96	8.0	13.0	14.2	45° 65,464
15°	774	0° - 60°	1,379	85%	2	94	88	82	92	86	81	88	84	10.0	8.3	17.8	55° 53,000
25°	667	0° - 90°	1,627	100%	3	84	76	70	82	75	70	79	73	12.0	5.8	21.3	65° 44,140
35°	519	90° - 180°	0	0%	4	75	67	61	74	66	60	71	65	14.0	4.2	24.9	75° 36,037
45°	368	0° - 180°	1,627	100%	5	68	60	53	67	59	53	65	58				85° 27,745
55°	242				6	62	53	47	61	53	47	59	52				
65°	148				7	57	48	43	56	48	42	54	47				
75°	74				8	52	44	39	51	44	38	50	43				
85°	19				9	48	40	35	48	40	35	46	40				
90°	0				10	45	37	32	44	37	32	43	37				

Beam Angle: 83.2°
Field Angle: 147.3°

WF8 SWW5 90CRI 3000K Input Watts: 19.7, Delivered Lumens: 1648, LPW: 83.7, S/MH: 1.09, Test No: ISF 202630P12

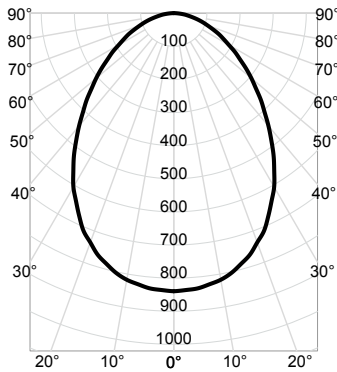

CP Summary	Zonal Lumen Summary				Coefficients of Utilization								Cone of Light			Luminance (cd/sq.m)	
	0°	Zone	Lumens	% Fixture	pf	80%		20%		70%		50%		Mounting Height	Initial FC Center Beam	Beam Diameter	Average Luminance
						pw	50%	30%	10%	50%	30%	10%	50%				
0°	840	0° - 30°	598	36%	0	119	119	119	116	116	116	111	111	6.0	23.3	10.7	0° 105,674
5°	834	0° - 40°	908	55%	1	106	102	98	104	100	97	99	96	8.0	13.1	14.2	45° 66,310
15°	784	0° - 60°	1,397	85%	2	94	88	82	92	86	81	88	84	10.0	8.4	17.8	55° 53,685
25°	676	0° - 90°	1,648	100%	3	84	76	70	82	75	70	79	73	12.0	5.8	21.3	65° 44,710
35°	525	90° - 180°	0	0%	4	75	67	61	74	66	60	71	65	14.0	4.3	24.9	75° 36,503
45°	373	0° - 180°	1,648	100%	5	68	60	53	67	59	53	65	58				85° 28,104
55°	245				6	62	53	47	61	53	47	59	52				
65°	150				7	57	48	43	56	48	42	54	47				
75°	75				8	52	44	39	51	44	38	50	43				
85°	19				9	48	40	35	48	40	35	46	40				
90°	0				10	45	37	32	44	37	32	43	37				

Beam Angle: 83.2°
Field Angle: 147.3°

WF8 SWW5 90CRI 3500K Input Watts: 19.7, Delivered Lumens: 1677, LPW: 85.1, S/MH: 1.09, Test No: ISF 202630P13

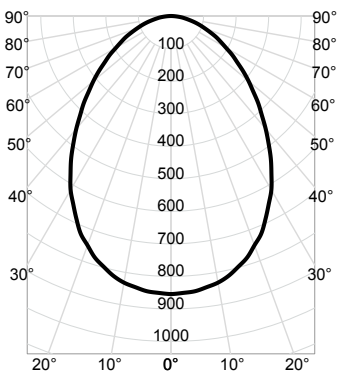

CP Summary	Zonal Lumen Summary				Coefficients of Utilization								Cone of Light			Luminance (cd/sq.m)	
	0°	Zone	Lumens	% Fixture	pf	80%		20%		70%		50%		Mounting Height	Initial FC Center Beam	Beam Diameter	Average Luminance
						pw	50%	30%	10%	50%	30%	10%	50%				
0°	854	0° - 30°	608	36%	0	119	119	119	116	116	116	111	111	6.0	23.7	10.7	0° 107,536
5°	849	0° - 40°	924	55%	1	106	102	98	104	100	97	99	96	8.0	13.4	14.2	45° 67,478
15°	798	0° - 60°	1,422	85%	2	94	88	82	92	86	81	88	84	10.0	8.5	17.8	55° 54,631
25°	688	0° - 90°	1,677	100%	3	84	76	70	82	75	70	79	73	12.0	5.9	21.3	65° 45,498
35°	535	90° - 180°	0	0%	4	75	67	61	74	66	60	71	65	14.0	4.4	24.9	75° 37,146
45°	379	0° - 180°	1,677	100%	5	68	60	53	67	59	53	65	58				85° 28,599
55°	249				6	62	53	47	61	53	47	59	52				
65°	153				7	57	48	43	56	48	42	54	47				
75°	76				8	52	44	39	51	44	38	50	43				
85°	20				9	48	40	35	48	40	35	46	40				
90°	0				10	45	37	32	44	37	32	43	37				

Beam Angle: 83.2°
Field Angle: 147.3°



Juno Wafer™ LED Downlight Series

4", 6" & 8" LED Ultra-Thin Wafer Switchable Downlight
5CCT Switchable White Downlight



PHOTOMETRICS

Distribution Curve

Distribution Data

Output Data

Coefficient of Utilization

Illuminance Data at 30" Above Floor for a Single Luminaire

WF8 SWW5 90CRI 4000K Input Watts: 19.7, Delivered Lumens: 1696, LPW: 86.1, S/MH: 1.09, Test No: ISF 202630P14

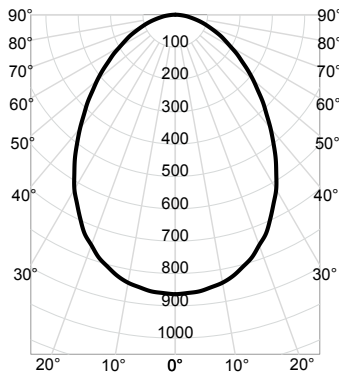

CP Summary		Zonal Lumen Summary				Coefficients of Utilization										Cone of Light			Luminance (cd/sq.m)	
0°	Zone	Lumens	% Fixture	pw	50%	30%	10%	50%	30%	10%	50%	30%	10%	Mounting Height	Initial FC Center Beam	Beam Diameter	Average Luminance			
0°	0° - 30°	615	36%	0	119	119	119	116	116	116	111	111	111	6.0	24.0	10.7	0°	108,755		
5°	0° - 40°	935	55%	1	106	102	98	104	100	97	99	96	94	8.0	13.5	14.2	45°	68,244		
15°	0° - 60°	1,438	85%	2	94	88	82	92	86	81	88	84	80	10.0	8.6	17.8	55°	55,250		
25°	0° - 90°	1,696	100%	3	84	76	70	82	75	70	79	73	68	12.0	6.0	21.3	65°	46,014		
35°	90° - 180°	0	0%	4	75	67	61	74	66	60	71	65	60	14.0	4.4	24.9	75°	37,567		
45°	0° - 180°	1,696	100%	5	68	60	53	67	59	53	65	58	53				85°	28,923		
55°		252		6	62	53	47	61	53	47	59	52	47							
65°		155		7	57	48	43	56	48	42	54	47	42							
75°		77		8	52	44	39	51	44	38	50	43	38							
85°		20		9	48	40	35	48	40	35	46	40	35							
90°		0		10	45	37	32	44	37	32	43	37	32							

Beam Angle: 83.2°
Field Angle: 147.3°

WF8 SWW5 90CRI 5000K Input Watts: 19.7, Delivered Lumens: 1705, LPW: 86.5, S/MH: 1.09, Test No: ISF 202630P15

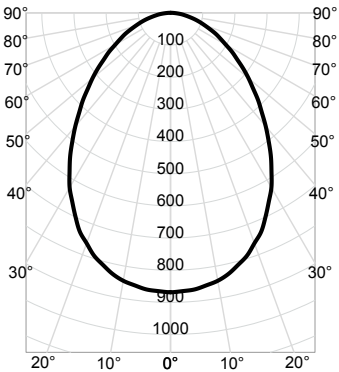

CP Summary		Zonal Lumen Summary				Coefficients of Utilization										Cone of Light			Luminance (cd/sq.m)	
0°	Zone	Lumens	% Fixture	pw	50%	30%	10%	50%	30%	10%	50%	30%	10%	Mounting Height	Initial FC Center Beam	Beam Diameter	Average Luminance			
0°	0° - 30°	618	36%	0	119	119	119	116	116	116	111	111	111	6.0	24.1	10.7	0°	109,333		
5°	0° - 40°	940	55%	1	106	102	98	104	100	97	99	96	94	8.0	13.6	14.2	45°	68,606		
15°	0° - 60°	1,445	85%	2	94	88	82	92	86	81	88	84	80	10.0	8.7	17.8	55°	55,544		
25°	0° - 90°	1,705	100%	3	84	76	70	82	75	70	79	73	68	12.0	6.0	21.3	65°	46,258		
35°	90° - 180°	0	0%	4	75	67	61	74	66	60	71	65	60	14.0	4.4	24.9	75°	37,767		
45°	0° - 180°	1,705	100%	5	68	60	53	67	59	53	65	58	53				85°	29,077		
55°		253		6	62	53	47	61	53	47	59	52	47							
65°		155		7	57	48	43	56	48	42	54	47	42							
75°		78		8	52	44	39	51	44	38	50	43	38							
85°		20		9	48	40	35	48	40	35	46	40	35							
90°		0		10	45	37	32	44	37	32	43	37	32							

Beam Angle: 83.2°
Field Angle: 147.3°