

Type No. _____
 Job Name _____
 Catalog No. _____



Outdoor Remote Lamp Heads

MR16 and White LED Lamp Assemblies

12 Volt Operation



Die Cast Aluminum MR16 Remote Head (LEF)

- Constructed of durable die cast aluminum
- Available in black or bronze
- 12 Volt, 20, 35 or 50 Watt MR16 lamps available
- Single or double mounting plates available



Shown: LEF1RBZ20WF



Shown: LEF2RBZ20WF



Shown: ORBBZ



Shown: OSBBZ

LEF				
SERIES	NUMBER OF HEADS	TYPE OF MOUNTING PLATE	COLOR	MR16 LAMP TYPE
LEF = Decorative Outdoor Remote Head	1 = Single Remote Head 2 = Double Remote Head	R = 4" Round Mounting Plate S = Single Gang Rectangular Mounting Plate	BK = Black BZ = Bronze	20WF = 12 Volt, 20 Watt Wide Flood 40° 35FL = 12 Volt, 35 Watt Flood 25° 35WF = 12 Volt, 35 Watt Wide Flood 40° 50FL = 12 Volt, 50 Watt Flood 25° 50WF = 12 Volt, 50 Watt Wide Flood 40°

ACCESSORIES (Ordered Separately)
ORBBK = Outdoor 4" Round Surface Mount Junction Box, Black
ORBZ = Outdoor 4" Round Surface Mount Junction Box, Bronze
OSBBK = Outdoor Single Gang, Surface/Recessed 2 3/4" x 4 1/2" Junction Box, Black
OSBBZ = Outdoor Single Gang, Surface/Recessed 2 3/4" x 4 1/2" Junction Box, Bronze

Die Cast Aluminum MR16 Recessed Lamp Head (LRE)

- Constructed of durable die cast aluminum
- Available in black or bronze
- 12 Volt, 20, 35 or 50 Watt MR16 lamps available
- Masonry, concrete or deck mounting only
- **Lamps sold separately**

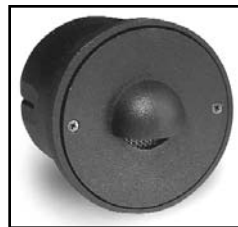

Shown: LREBK

SERIES
LREBK = Outdoor Remote Head Recessed, Black
LREBZ = Outdoor Remote Head Recessed, Bronze

MR16 Lamp Options

Description

- 12 Volt, 20 Watt, 40° beam spread
- 12 Volt, 35 Watt, 25° beam spread
- 12 Volt, 35 Watt, 40° beam spread
- 12 Volt, 50 Watt, 25° beam spread
- 12 Volt, 50 Watt, 40° beam spread

How to Order

- 12MR20WFL
- 12MR35FL
- 12MR35WFL
- 12MR50FL
- 12MR50WFL

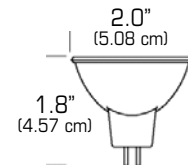

Die Cast Aluminum White LED Recessed Lamp Head (NightWatch)

- Constructed of durable die cast aluminum
- Available in black, white or ivory
- 12 Volt AC or DC, 10 Watt white LED array
- Installs into single gang metal junction box (supplied by others)



Shown: S1CBK

SERIES
S1CBK = Outdoor LED Luminaire, Black
S1CWH = Outdoor LED Luminaire, White
S1CIV = Outdoor LED Luminaire, Ivory

Specification Data for Outdoor Remote Lamp Heads

MR16 Remote Head with Mounting Plate (LEF)

Single Remote Head with Round Mounting Plate

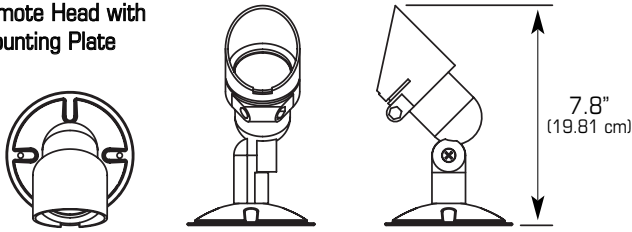

10' x 15' Calc Area
 20W MR16 Flood Mounting Height 10'
Illuminance Values (Fc)
 Average = 1.02
 Maximum = 2.6
 Minimum = 0.3
 Avg/Min Ratio = 3.4
 Max/Min Ratio = 8.67

Double Remote Heads with Round Mounting Plate

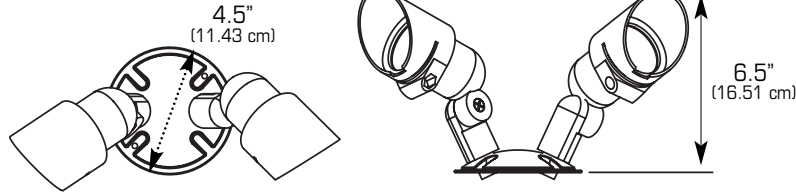

Single Remote Head with Rectangular Mounting Plate

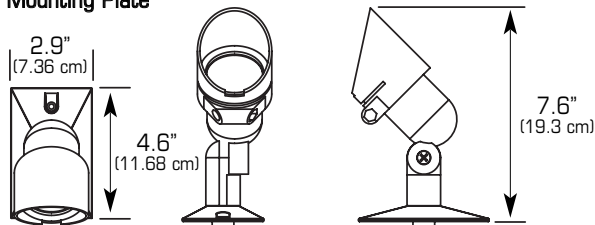

Junction Boxes For CEF (ORBBZ)

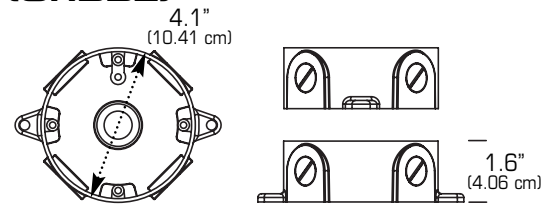

(OSBBZ)

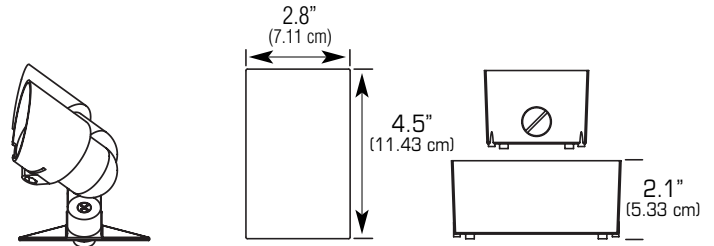

Double Remote Heads with Rectangular Mounting Plate

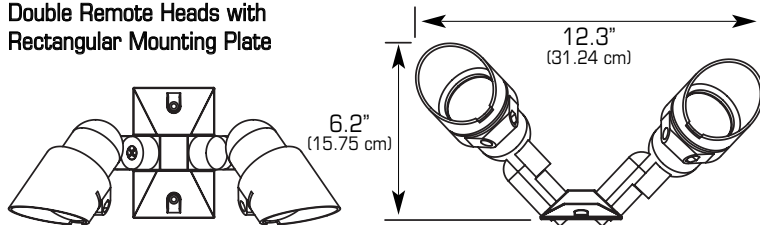

MR16 Recessed Lamp Head (LRE)

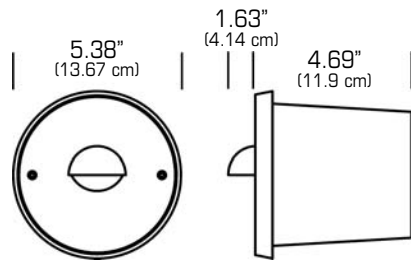

5' x 15' Calc Area
 35W MR16 Mounting Height 2'
Illuminance Values (Fc)
 Average = 1.03
 Maximum = 3.06
 Minimum = 0.3
 Avg/Min Ratio = 3.43
 Max/Min Ratio = 10.2

White LED Recessed Lamp Head (S1)

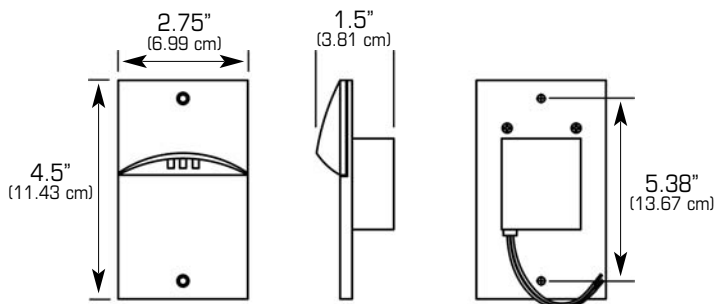

4' x 6' Calc Area
 LED Luminaire Mounting Height 1.5'
Illuminance Values (Fc)
 Average = 1.64
 Maximum = 4.2
 Minimum = 0.5
 Avg/Min Ratio = 3.28
 Max/Min Ratio = 8.40

Dimensions are approximate and subject to change.



272 West Stag Park Service Road • Burgaw NC 28425
 Telephone: (910) 259 1131 • Facsimile: (800) 403 6927
 www.lightguard.com

L2322R9
 5/09 IH