

KT-HBLED105PS-2FB-8CSD-VDIM-P

LED HIGH BAY FIXTURE

DESCRIPTION

2' LED High Bay Fixture | 120–277V Input | Frosted Lens | 0–10V Dimming | Premium Series

APPLICATION

Used for commercial and industrial high bay lighting applications



PRODUCT FEATURES

- Powered by Keystone 0–10V dimming LED drivers
- Smooth diffused lens for an even appearance
- 0–10V Dimming, Dim-to-off
- Compatible with Keystone SmartSafe emergency LED drivers
- Compatible with Keystone 480–277V step down transformers
- Features Keystone Power Select technology. Adjust power between 400/320/240W, changing lumen output to set high end trim.
- Features Keystone Color Select technology. Adjust CCT between 4000/5000K
- Built in port to accept Quick install Keystone sensor (KTS-MW3-12V-PKO & KTS-PIR3-12V-PKO.) NO wiring required
- Ambient operating temperature: –40°C/–40°F to 50°C/122°F
- UL Listed 1598: Suitable for damp locations
- THD: < 20%
- Power factor > 0.95
- L70 > 50,000 hours
- DLC Premium Listed
- Architectural grade compact design
- Frosted lens eliminates glare
- V-hook and chain mounting accessories included
- Compatible with Keystone SmartSafe emergency LED drivers; KT-EMRG-LED-12C-1200-EN /DF and KT-EMRG-LED-20SD-2000-EN /DF are optimal for fixture level installation; mounting kit KT-HBLED-EM-BR-1B-KIT required (sold separately)

POWER AND COLOR TEMPERATURE SELECTABILITY

- Keystone Color Select Technology: Adjustable CCT (4000K/5000K)
- Keystone Power Select Technology: Adjustable Wattage (105W/90W/65W)



PRODUCT SPECIFICATIONS

Catalog Number	Input Voltage	Wattage	CCT	Lumen Output	Efficacy	CRI	Power Factor	Lifetime
KT-HBLED105PS-2FB-8CSD-VDIM-P	120–277V	105W	4000K	15,200	145 lm/W	> 80	> 0.90	50,000 hrs
			5000K	15,300	146 lm/W			
		90W	4000K	13,400	149 lm/W			
			5000K	13,500	150 lm/W			
		65W	4000K	10,100	155 lm/W			
			5000K	10,200	157 lm/W			

ONE CATALOG NUMBER WITH 6 DIFFERENT OPTIONS

* Preset to highest lumen output (105W / 5000K)
 * Color Uniformity: CCT (Correlated Color Temperature) range as per guidelines outlined in ANSI C78.377-2017.

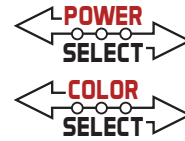

KT-HBLEDD105PS-2FB-8CSD-VDIM-P

LED HIGH BAY FIXTURE

PHOTOMETRIC SPECIFICATIONS

ISOCANDELA PLOT

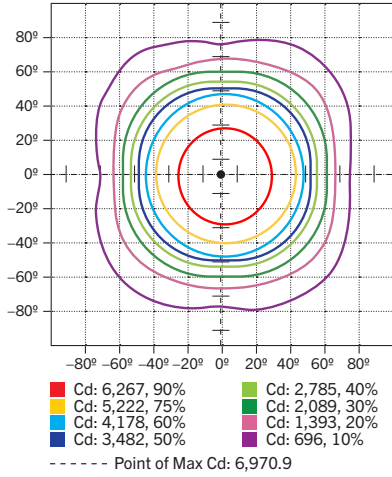

AVERAGE ILLUMINANCE

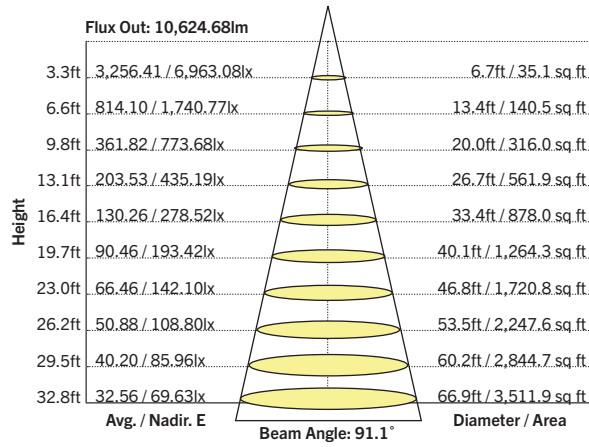

ZONAL LUMEN SUMMARY

Zone	Lumens	% Luminaire
0-30	5,456	35%
0-40	8,882	58%
0-60	13,618	88%
60-90	3,353	11%
70-100	765	5%
90-120	7	0%
0-90	15,406	99%
90-180	37	1%
0-180	15,440	100%

PHYSICAL SPECIFICATIONS

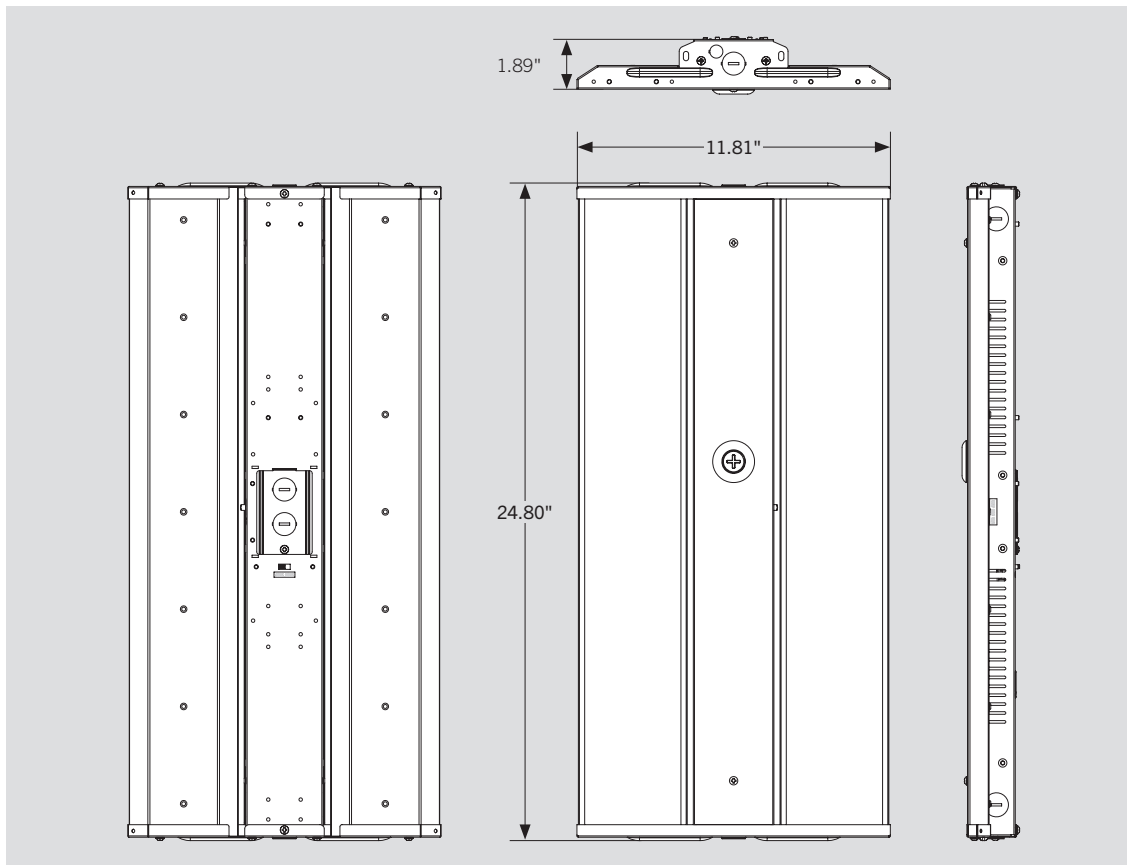

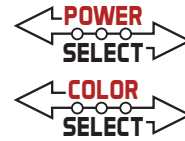

KT-HBLEDD105PS-2FB-8CSD-VDIM-P

LED HIGH BAY FIXTURE

ACCESSORIES

SENSORS

Factory-Installable OR Field-Installable (field-installable purchased separately)

✓	SUFFIX*	CATALOG NUMBER	DESCRIPTION	UPC	EASY CODE
	/FC3	KTSL-FC3-12V-PKO-PIR	Bluetooth mesh wireless screw-in low voltage PIR motion sensor and fixture controller for SmartLoop system; with daylight detection 	843654138862	OCW-60
	/PIR2	KTS-PIR2-UV-KO	PIR motion sensor with daylight detection; Preset for 5 min hold time, 10 min standby time at 10% dim, daylight disabled. Adjustable settings via remote control commissioning	843654123288	IOF-04
	/PIR-A	KTS-PIR3-12V-PKO /A	Smart Port PIR motion sensor with daylight detection; Preset for 1 min hold time, 3 min standby time at 30% dim, daylight disabled. Adjustable settings via remote control commissioning	843654133638	RXQ-30
	/PIR-B	KTS-PIR3-12V-PKO /B	Smart Port PIR motion sensor with daylight detection; Preset for 5 min hold time, 10 min standby time at 10% dim, daylight disabled. Adjustable settings via remote control commissioning	843654133645	LEF-34
	/MW3-A	KTS-MW3-12V PKO /A	Screw-in microwave motion sensor with daylight detection; Preset for 1 min hold time, 3 min standby time at 30% dim, daylight disabled. Adjustable settings via remote control commissioning	843654133317	XYR-25
	/MW3-B	KTS-MW3-12V PKO /B	Screw-in microwave motion sensor with daylight detection; Preset for 5 min hold time, 10 min standby time at 10% dim, daylight disabled Adjustable settings via remote control commissioning	843654133324	SPF-37



* For factory installation of accessory, add suffix to fixture part number (see ordering examples and instructions on last page of spec sheet).

Field-Installable / Field-Use ONLY (purchased separately)

CATALOG NUMBER	DESCRIPTION	UPC	EASY CODE
KTS-MW3-REMOTECONTROL	Remote control for KTS-MW3-12V-PKO /A or /B and KTS-PIR3-12V-PKO /A or /B sensors. Used to set and adjust all sensor settings, including high-end trim brightness, sensitivity, hold time, daylight threshold, stand-by time, and stand-by dimming level.	843654132020	XSR-61

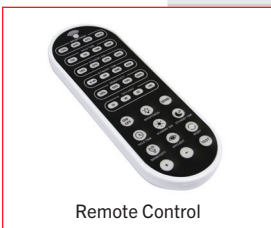

(Accessories continued on next page)

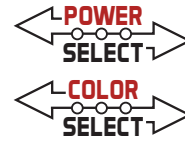

KT-HBLEDD105PS-2FB-8CSD-VDIM-P

LED HIGH BAY FIXTURE

ACCESSORIES (continued)

CORD SETS

Factory-Installable OR Field-Installable (field-installable purchased separately)

✓	SUFFIX*	CATALOG NUMBER	DESCRIPTION	UPC	EASY CODE
	/515P6	KT-CS-515P-6-18/3	Cord set for high bay; 125V NEMA 5-15P; straight blade plug; 6' SJTOW cable; 18/3 wire	843654140124	UKH-26
	/L715P10	KT-CS-L715P-10-16/3	Cord set for high bays; 277V NEMA L7-15P; twist lock plug; 10' SJTOW cable; 16/3 wire	843654140131	SFV-88
	/L615P10	KT-CS-L615P-10-16/3	Cord set for high bays; 250V NEMA L6-15P; twist lock plug; 10' SJTOW cable; 16/3 wire	843654140148	ZQS-05
	/L515P10	KT-CS-L515P-10-16/3	Cord set for high bays; 250V NEMA L5-15P; twist lock plug; 10' SJTOW cable; 16/3 wire	843654140155	GVH-22
	/L715P6	KT-CS-L715P-6-16/3	Cord set for high bays; 277V NEMA L7-15P; twist lock plug; 6' SJTOW cable; 16/3 wire	843654140162	DVU-44
	/L615P6	KT-CS-L615P-6-16/3	Cord set for high bays; 250V NEMA L6-15P; twist lock plug; 6' SJTOW cable; 16/3 wire	843654140179	LCW-66
	/L515P6	KT-CS-L515P-6-16/3	Cord set for high bays; 250V NEMA L5-15P; twist lock plug; 6' SJTOW cable; 16/3 wire	843654140186	POC-82
	/MC63	KT-MC-NP-6-18/3	MC cable whip for high bays; no plug; inners 1/2" strip on both ends; 6' metal-clad cable; 18/3 wire	843654134505	EYP-82
	/MC65	KT-MC-NP-6-18/5	MC cable whip for high bays; no plug; inners 1/2" strip on both ends; 6' metal-clad cable; 18/5 wire (dimming wires included)	843654134512	CBU-56
	/NP10	KT-CS-NP-10-16/3	Cord for high bays; no plug; inners 1/2" strip on both ends; 10' SJTOW cable; 16/3 wire	843654140193	YOH-90
	/NP6	KT-CS-NP-6-16/3	Cord for high bays; no plug; inners 1/2" strip on both ends; 6' SJTOW cable; 16/3 wire	843654140216	HUB-73
	/NP15	KT-CS-NP-15-16/3	Cord for high bays; no plug; inners 1/2" strip on both ends; 15' SJTOW cable; 16/3 wire	843654140209	EYD-18



Cord Sets

* For factory installation of accessory, add suffix to fixture part number (see ordering examples and instructions on last page of spec sheet).
Note: For cord sets not listed here, please contact your Keystone sales rep.

(Accessories continued on next page)

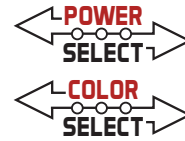

KT-HBLED105PS-2FB-8CSD-VDIM-P

LED HIGH BAY FIXTURE

ACCESSORIES (continued)

EMERGENCY BACKUP

Factory-Installable OR Field-Installable (field-installable purchased separately)

✓	SUFFIX*	CATALOG NUMBER	DESCRIPTION	UPC	EASY CODE
	/EM5 [†]	KT-EMRG-LED-5C-500-EN /DF	5W, 500 lumen Smart Safe emergency backup with dual flex cables	843654132433	RAR-74
	/EM12 [†]	KT-EMRG-LED-12C-1200-EN /DF	12W, 1200 lumen Smart Safe emergency backup with dual flex cables	890949019900	YCV-23
	/EM20 [†]	KT-EMRG-LED-20SD-2000-EN /DF	20W, 2000 lumen Smart Safe emergency backup with dual flex cables; Self-diagnostic	843654103143	BZU-19

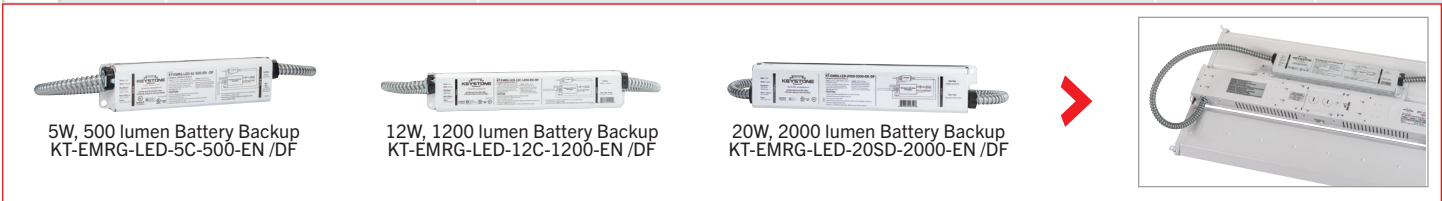

* For factory installation of accessory, add suffix to fixture part number (see ordering examples and instructions on last page of spec sheet).
[†] Factory installation of emergency backup units will automatically include any relevant mounting bracket.

Field-Installable / Field-Use ONLY (purchased separately)

CATALOG NUMBER	DESCRIPTION	UPC	EASY CODE
KT-HBLED-EM-BR-1B-KIT	Emergency LED backup mounting bracket kit for LED high bay fixtures	843654133737	LAJ-08

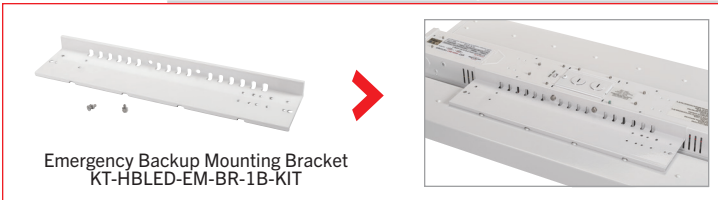

(Accessories continued on next page)

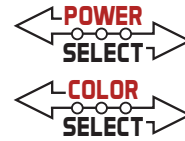

KT-HBLEDD105PS-2FB-8CSD-VDIM-P

LED HIGH BAY FIXTURE

ACCESSORIES (continued)

MOUNTS AND BRACKETS

Factory-Installable OR Field-Installable (field-installable purchased separately)

✓	SUFFIX*	CATALOG NUMBER	DESCRIPTION	UPC	EASY CODE
	/WG-1	KT-HBLEDD-WG-2B-KIT	Wire guard kit for 2FB Linear LED high bay fixtures	843654134765	GSX-74

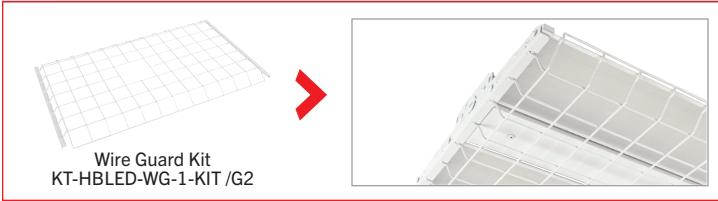

* For factory installation of accessory, add suffix to fixture part number (see ordering examples and instructions on last page of spec sheet).

Field-Installable / Field-Use ONLY (purchased separately)

CATALOG NUMBER	DESCRIPTION	UPC	EASY CODE
KT-HBLEDD-PM-1B-KIT	Pendant mount kit for LED high bay fixtures	843654133706	XAA-31
KT-HBLEDD-SM-1B-KIT	Surface mount kit for LED high bay fixtures	843654133690	LGJ-33
KT-HBLEDD-CABLE-1B-KIT	Aircraft cable hanging kit for LED high bay fixtures	843654133720	WMG-60

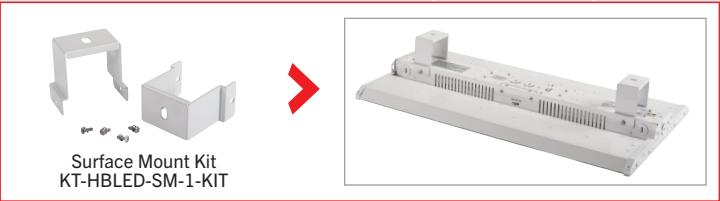
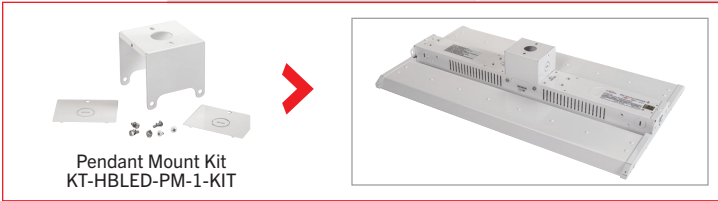

STEP-DOWN TRANSFORMERS

Factory-Installable OR Field-Installable (field-installable purchased separately)

✓	SUFFIX*	CATALOG NUMBER	DESCRIPTION	UPC	EASY CODE
	/480†‡	KTAT-250-480-277 /SF	Fully enclosed, single flex step-down transformer for LED high bay fixtures (250VA or lower)	843654102931	XIM-17

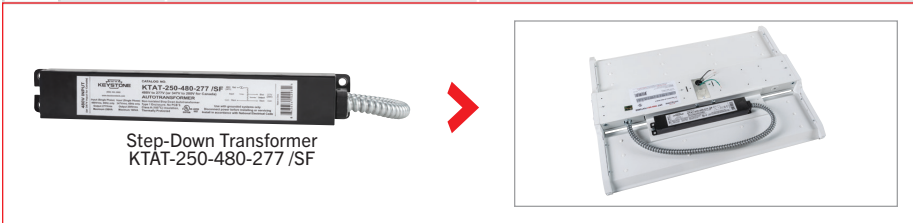

* For factory installation of accessory, add suffix to fixture part number (see ordering examples and instructions on last page of spec sheet).

† Factory installation of step-down transformer units will automatically include any relevant mounting bracket.

‡ Step-down transformers cannot be ordered in conjunction with standard SJTOW cord set options (contact Keystone sales rep for available custom options if needed).

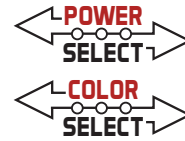

KT-HBLED105PS-2FB-8CSD-VDIM-P

LED HIGH BAY FIXTURE

ORDERING INFORMATION

Catalog Number	Pack Quantity	Easy Code	UPC
KT-HBLED105PS-2FB-8CSD-VDIM-P	TBD	WGG-22	843654134567

CATALOG NUMBER BREAKDOWN

KT-HBLED105PS-2FB-8CSD-VDIM-P

1	2	3	4	5	6	7	8	9	10	11
1 Keystone Technologies	2 LED Stairwell Fixture	3 Wattage	4 Power Select	5 2' Nominal Length	6 Form Factor	7 800 Series	8 Color Select	9 Color Select Designation	10 0–10V Dimming	11 Premium Series

8 Color Select Designation	
A	3500K, 4000K, 5000K
B	3000K, 4000K, 5000K
C	3000K, 3500K, 4000K, 5000K
D	4000K, 5000K

ORDERING EXAMPLES

FIXTURE WITH MULTIPLE FACTORY-INSTALLED ACCESSORIES*

KT-HBLED155-2F-840-VDIM-P /G2/PIR2/L715P6/EM5/WG-1

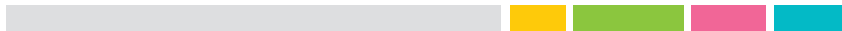

FIXTURE WITH MULTIPLE FACTORY-INSTALLED ACCESSORIES*

KT-HBLED155-2F-840-VDIM-P /G2/PIR2/EM5/WG-1/480

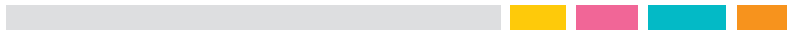

FIXTURE WITH TWO FACTORY-INSTALLED ACCESSORIES*

KT-HBLED155-2F-840-VDIM-P /G2/PIR2/480

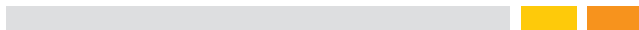

FIXTURE WITH SINGLE FACTORY-INSTALLED ACCESSORY

KT-HBLED155-2F-840-VDIM-P /G2/PIR2

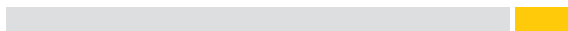

FIXTURE WITH NO FACTORY-INSTALLED ACCESSORIES

KT-HBLED155-2F-840-VDIM-P /G2

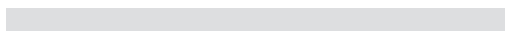

KEYSTONE FIXTURE	
CATALOG NUMBER	
	KT-HBLED155-2F-840-VDIM-P /G2

SENSORS	
SUFFIX	CATALOG NUMBER
<input checked="" type="checkbox"/> /PIR2	KTS-PIR2-UV-KO

CORD SETS	
SUFFIX	CATALOG NUMBER
<input checked="" type="checkbox"/> /L715P6	KT-CS-L715P-6-16/3

EMERGENCY BACKUP	
SUFFIX	CATALOG NUMBER
<input checked="" type="checkbox"/> /EM5	KT-EMRG-LED-5C-500-EN /DF

MOUNTS AND BRACKETS	
SUFFIX	CATALOG NUMBER
<input checked="" type="checkbox"/> /WG-1	KT-HBLED-WG-1-KIT /G2

STEP-DOWN TRANSFORMERS	
SUFFIX	CATALOG NUMBER
<input checked="" type="checkbox"/> /480	KTAT-250-480-277 /SF

Note: Step-down transformers cannot be ordered in conjunction with standard SJTOW cord set options (contact Keystone sales rep for available custom options if needed).

* When ordering more than one factory-installed accessory, use multiple suffixes as shown in the ordering examples above.
 Note: All accessories can also be ordered separately for field installation using just their regular Catalog Number, UPC, or Easy Code.

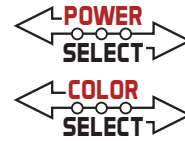

KT-HBLED215PS-2FB-8CSD-VDIM-P

LED HIGH BAY FIXTURE

DESCRIPTION

2' LED High Bay Fixture | 120–277V Input | Frosted Lens |
0–10V Dimming | Premium Series

APPLICATION

Used for commercial and industrial high bay lighting applications



PRODUCT FEATURES

- Powered by Keystone 0–10V dimming LED drivers
- Smooth diffused lens for an even appearance
- 0–10V Dimming, Dim-to-off
- Compatible with Keystone SmartSafe emergency LED drivers
- Compatible with Keystone 480–277V step down transformers
- Built in port to accept Quick install Keystone sensor (KTS-MW3-12V-PKO & KTS-PIR3-12V-PKO.) NO wiring required
- Ambient operating temperature: –40°C/–40°F to 50°C/122°F
- UL Listed 1598: Suitable for damp locations
- THD: < 20%
- Power factor > 0.95
- L70 > 100,000 hours
- DLC Premium Listed
- Architectural grade compact design
- Frosted lens eliminates glare
- V-hook and chain mounting accessories included
- Compatible with Keystone SmartSafe emergency LED drivers; KT-EMRG-LED-12C-1200-EN/DF and KT-EMRG-LED-20SD-2000-EN/DF are optimal for fixture level installation; mounting kit KT-HBLED-EM-BR-1B-KIT required (sold separately)

POWER AND COLOR TEMPERATURE SELECTABILITY

- Keystone Color Select Technology: Adjustable CCT (4000K/5000K)
- Keystone Power Select Technology: Adjustable Wattage (215W/175W/135W)



PRODUCT SPECIFICATIONS

Catalog Number	Input Voltage	Wattage	CCT	Lumen Output	Efficacy	CRI	Power Factor	Lifetime
KT-HBLED215PS-2FB-8CSD-VDIM-P	120–277V	215W	4000K	30,500	142 lm/W	> 80	> 0.90	50,000 hrs
			5000K	30,600	142 lm/W			
		175W	4000K	25,900	148 lm/W			
			5000K	26,000	149 lm/W			
		135W	4000K	20,800	154 lm/W			
			5000K	20,900	155 lm/W			

ONE CATALOG NUMBER WITH 6 DIFFERENT OPTIONS

* Preset to highest lumen output (215W / 5000K)

* Color Uniformity: CCT (Correlated Color Temperature) range as per guidelines outlined in ANSI C78.377-2017.

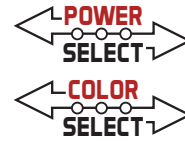

KT-HBLEDD215PS-2FB-8CSD-VDIM-P

LED HIGH BAY FIXTURE

PHOTOMETRIC SPECIFICATIONS

ISOCANDELA PLOT

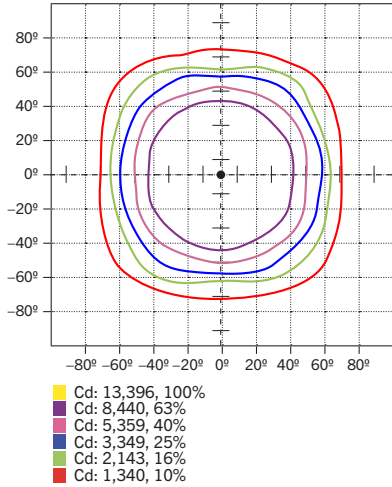

AVERAGE ILLUMINANCE

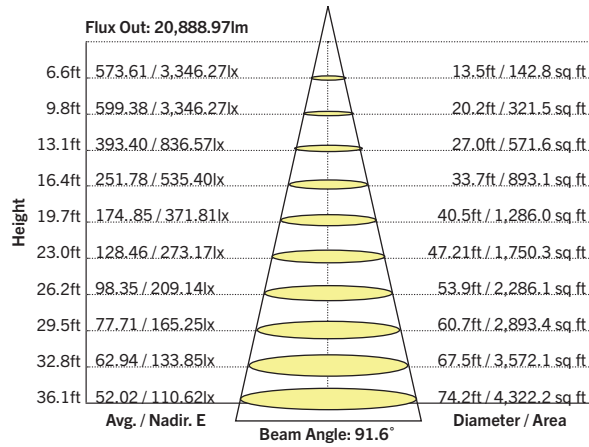

ZONAL LUMEN SUMMARY

Zone	Lumens	% Luminaire
0-60	27,071	88%
60-90	3,353	11%
0-90	30,424	99%
90-180	256	1%
0-180	30,680	100%

PHYSICAL SPECIFICATIONS

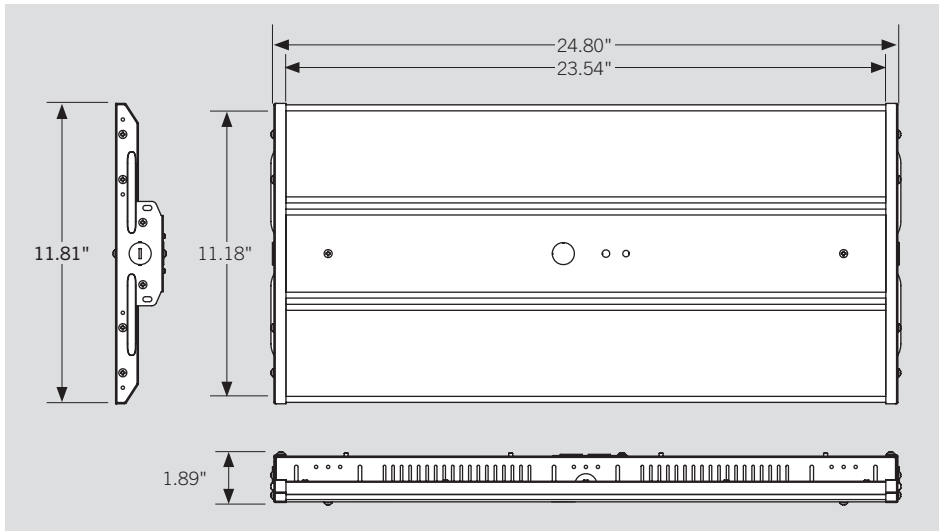

Weight	12.6 lb
--------	---------

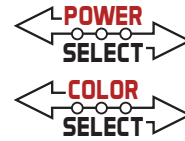

KT-HBLEDD215PS-2FB-8CSD-VDIM-P

LED HIGH BAY FIXTURE

ACCESSORIES

SENSORS

Factory-Installable OR Field-Installable (field-installable purchased separately)

✓	SUFFIX*	CATALOG NUMBER	DESCRIPTION	UPC	EASY CODE
	/FC3	KTSL-FC3-12V-PKO-PIR	Smart Loop Bluetooth mesh screw-in PIR occupancy sensor with built-in fixture controller. No wiring required.	843654138862	OCW-60
	/PIR2	KTS-PIR2-UV-KO	PIR sensor for high bay fixtures; Preset for 5 min hold time, 10 min standby time at 10% dim, daylight disabled	843654123288	IOF-04
	/PIR-A	KTS-PIR3-12V-PKO /A	Smart Port PIR sensor for high bay fixtures; Preset for 1 min hold time, 3 min standby time at 30% dim, daylight disabled	843654133638	RXQ-30
	/PIR-B	KTS-PIR3-12V-PKO /B	Smart Port PIR sensor for high bay fixtures; Preset for 5 min hold time, 10 min standby time at 10% dim, daylight disabled	843654133645	LEF-34
	/MW3-A	KTS-MW3-12V PKO /A	Smart Port Microwave Occupancy sensor for high bay fixtures; Preset for 1 min hold time, 3 min standby time at 30% dim, daylight disabled	843654133317	XYR-25
	/MW3-B	KTS-MW3-12V PKO /B	Smart Port Microwave Occupancy sensor for high bay fixtures; Preset for 5 min hold time, 10 min standby time at 10% dim, daylight disabled	843654133324	SPF-37



Field-Installable / Field-Use ONLY (purchased separately)

CATALOG NUMBER	DESCRIPTION	UPC	EASY CODE
KTS-MW3-REMOTECONTROL	Remote control for KTS-MW3-12V-PKO /A or /B and KTS-PIR3-12V-PKO /A or /B sensors. Used to set and adjust all sensor settings, including high-end trim brightness, sensitivity, hold time, daylight threshold, stand-by time, and stand-by dimming level.	843654132020	XSR-61

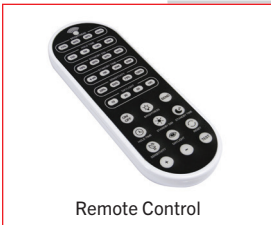

(Accessories continued on next page)

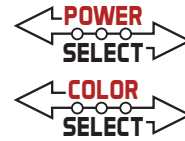

KT-HBLEDD215PS-2FB-8CSD-VDIM-P

LED HIGH BAY FIXTURE

ACCESSORIES (continued)

CORD SETS

Factory-Installable OR Field-Installable (field-installable purchased separately)

✓	SUFFIX*	CATALOG NUMBER	DESCRIPTION	UPC	EASY CODE
	/515P6	KT-CS-515P-6-18/3	Cord set for high bay; 125V NEMA 5-15P; straight blade plug; 6' SJTOW cable; 18/3 wire	843654140124	UKH-26
	/L715P10	KT-CS-L715P-10-16/3	Cord set for high bays; 277V NEMA L7-15P; twist lock plug; 10' SJTOW cable; 16/3 wire	843654140131	SFV-88
	/L615P10	KT-CS-L615P-10-16/3	Cord set for high bays; 250V NEMA L6-15P; twist lock plug; 10' SJTOW cable; 16/3 wire	843654140148	ZQS-05
	/L515P10	KT-CS-L515P-10-16/3	Cord set for high bays; 250V NEMA L5-15P; twist lock plug; 10' SJTOW cable; 16/3 wire	843654140155	GVH-22
	/L715P6	KT-CS-L715P-6-16/3	Cord set for high bays; 277V NEMA L7-15P; twist lock plug; 6' SJTOW cable; 16/3 wire	843654140162	DVU-44
	/L615P6	KT-CS-L615P-6-16/3	Cord set for high bays; 250V NEMA L6-15P; twist lock plug; 6' SJTOW cable; 16/3 wire	843654140179	LCW-66
	/L515P6	KT-CS-L515P-6-16/3	Cord set for high bays; 250V NEMA L5-15P; twist lock plug; 6' SJTOW cable; 16/3 wire	843654140186	POC-82
	/MC63	KT-MC-NP-6-18/3	MC cable whip for high bays; no plug; inners 1/2" strip on both ends; 6' metal-clad cable; 18/3 wire	843654134505	EYP-82
	/MC65	KT-MC-NP-6-18/5	MC cable whip for high bays; no plug; inners 1/2" strip on both ends; 6' metal-clad cable; 18/5 wire (dimming wires included)	843654134512	CBU-56
	/NP10	KT-CS-NP-10-16/3	Cord for high bays; no plug; inners 1/2" strip on both ends; 10' SJTOW cable; 16/3 wire	843654140193	YOH-90
	/NP6	KT-CS-NP-6-16/3	Cord for high bays; no plug; inners 1/2" strip on both ends; 6' SJTOW cable; 16/3 wire	843654140216	HUB-73
	/NP15	KT-CS-NP-15-16/3	Cord for high bays; no plug; inners 1/2" strip on both ends; 15' SJTOW cable; 16/3 wire	843654140209	EYD-18



Cord Sets

* For factory installation of accessory, add suffix to fixture part number (see ordering examples and instructions on last page of spec sheet).
 Note: For cord sets not listed here, please contact your Keystone sales rep.

(Accessories continued on next page)

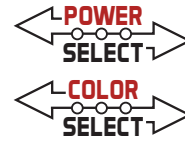

KT-HBLED215PS-2FB-8CSD-VDIM-P

LED HIGH BAY FIXTURE

ACCESSORIES (continued)

EMERGENCY BACKUP

Factory-Installable OR Field-Installable (field-installable purchased separately)

<input checked="" type="checkbox"/>	SUFFIX*	CATALOG NUMBER	DESCRIPTION	UPC	EASY CODE
	/EM5 [†]	KT-EMRG-LED-5C-500-EN /DF	5W, 500 lumen Smart Safe emergency backup with dual flex cables	843654132433	RAR-74
	/EM12 [†]	KT-EMRG-LED-12C-1200-EN /DF	12W, 1200 lumen Smart Safe emergency backup with dual flex cables	890949019900	YCV-23
	/EM20 [†]	KT-EMRG-LED-20SD-2000-EN /DF	20W, 2000 lumen Smart Safe emergency backup with dual flex cables; Self-diagnostic	843654103143	BZU-19

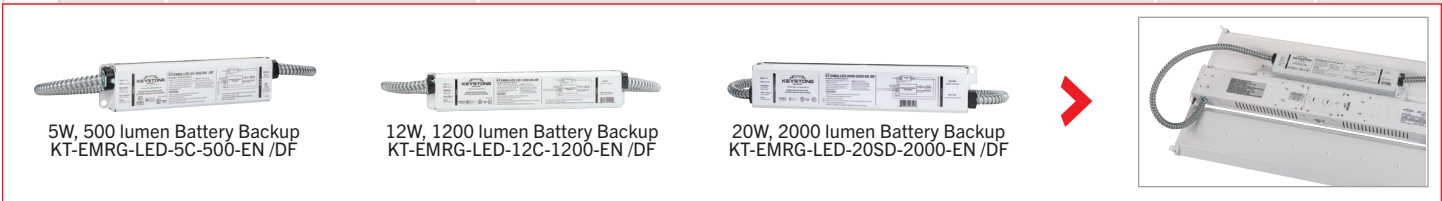

* For factory installation of accessory, add suffix to fixture part number (see ordering examples and instructions on last page of spec sheet).
[†] Factory installation of emergency backup units will automatically include any relevant mounting bracket.

Field-Installable / Field-Use ONLY (purchased separately)

CATALOG NUMBER	DESCRIPTION	UPC	EASY CODE
KT-HBLED-EM-BR-1B-KIT	Emergency LED backup mounting bracket kit for LED high bay fixtures	843654133737	LAJ-08

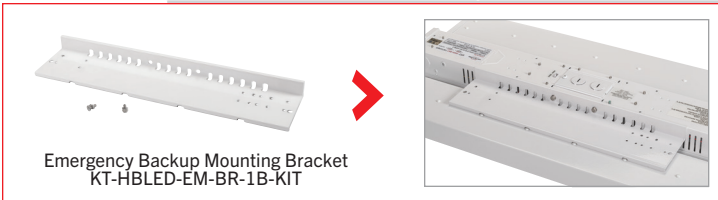

(Accessories continued on next page)

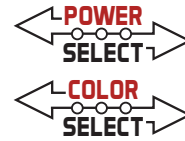

KT-HBLEDD215PS-2FB-8CSD-VDIM-P

LED HIGH BAY FIXTURE

ACCESSORIES (continued)

MOUNTS AND BRACKETS

Factory-Installable OR Field-Installable (field-installable purchased separately)

✓	SUFFIX*	CATALOG NUMBER	DESCRIPTION	UPC	EASY CODE
	/WG-1	KT-HBLEDD-WG-1B-KIT	Wire guard kit for 2FB Linear LED high bay fixtures	843654133713	STK-79

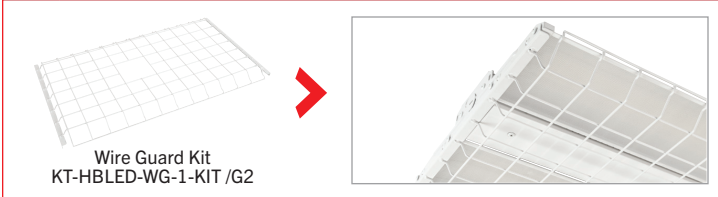

* For factory installation of accessory, add suffix to fixture part number (see ordering examples and instructions on last page of spec sheet).

Field-Installable / Field-Use ONLY (purchased separately)

CATALOG NUMBER	DESCRIPTION	UPC	EASY CODE
KT-HBLEDD-PM-1B-KIT	Pendant mount kit for LED high bay fixtures	843654133706	XAA-31
KT-HBLEDD-SM-1B-KIT	Surface mount kit for LED high bay fixtures	843654133690	LGJ-33
KT-HBLEDD-CABLE-1B-KIT	Aircraft cable hanging kit for LED high bay fixtures	843654133720	WMG-60

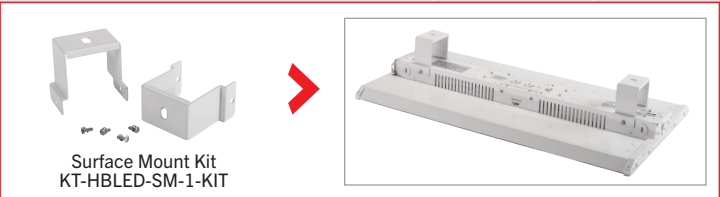
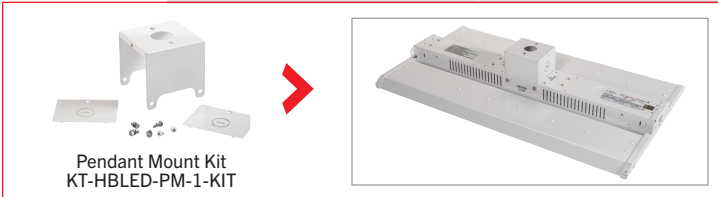

STEP-DOWN TRANSFORMERS

Factory-Installable OR Field-Installable (field-installable purchased separately)

✓	SUFFIX*	CATALOG NUMBER	DESCRIPTION	UPC	EASY CODE
	/480†‡	KTAT-250-480-277 /SF	Fully enclosed, single flex step-down transformer for LED high bay fixtures (250VA or lower)	843654102931	XIM-17

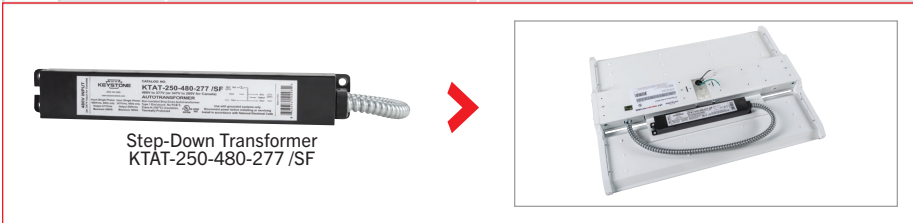

* For factory installation of accessory, add suffix to fixture part number (see ordering examples and instructions on last page of spec sheet).

† Factory installation of step-down transformer units will automatically include any relevant mounting bracket.

‡ Step-down transformers cannot be ordered in conjunction with standard SJTOW cord set options (contact Keystone sales rep for available custom options if needed).

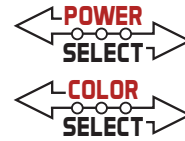

KT-HBLED215PS-2FB-8CSD-VDIM-P

LED HIGH BAY FIXTURE

ORDERING INFORMATION

Catalog Number	Pack Quantity	Easy Code	UPC
KT-HBLED215PS-2FB-8CSD-VDIM-P	TBD	FPM-04	843654133652

CATALOG NUMBER BREAKDOWN

KT-HBLED215PS-2FB-8CSD-VDIM-P

1	2	3	4	5	6	7	8	9	10	11
1 Keystone Technologies	2 LED High Bay Fixture	3 Wattage	4 Power Select	5 2' Nominal Length	6 Form Factor	7 800 Series	8 Color Select	9 Color Select Designation	10 0–10V Dimming	11 Premium Series

8 Color Select Designation	
A	3500K, 4000K, 5000K
B	3000K, 4000K, 5000K
C	3000K, 3500K, 4000K, 5000K
D	4000K, 5000K

ORDERING EXAMPLES

FIXTURE WITH MULTIPLE FACTORY-INSTALLED ACCESSORIES*

KT-HBLED155-2F-840-VDIM-P /G2/PIR2/L715P6/EM5/WG-1



FIXTURE WITH MULTIPLE FACTORY-INSTALLED ACCESSORIES*

KT-HBLED155-2F-840-VDIM-P /G2/PIR2/EM5/WG-1/480

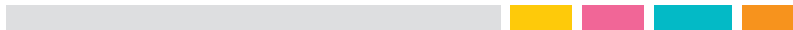

FIXTURE WITH TWO FACTORY-INSTALLED ACCESSORIES*

KT-HBLED155-2F-840-VDIM-P /G2/PIR2/480

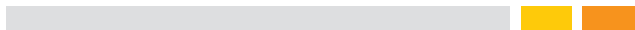

FIXTURE WITH SINGLE FACTORY-INSTALLED ACCESSORY

KT-HBLED155-2F-840-VDIM-P /G2/PIR2

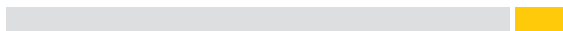

FIXTURE WITH NO FACTORY-INSTALLED ACCESSORIES

KT-HBLED155-2F-840-VDIM-P /G2

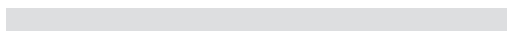

KEYSTONE FIXTURE	
CATALOG NUMBER	
KT-HBLED155-2F-840-VDIM-P /G2	

SENSORS	
SUFFIX	CATALOG NUMBER
<input checked="" type="checkbox"/> /PIR2	KTS-PIR2-UV-KO

CORD SETS	
SUFFIX	CATALOG NUMBER
<input checked="" type="checkbox"/> /L715P6	KT-CS-L715P6-16/3

EMERGENCY BACKUP	
SUFFIX	CATALOG NUMBER
<input checked="" type="checkbox"/> /EM5	KT-EMRG-LED-5C-500-EN /DF

MOUNTS AND BRACKETS	
SUFFIX	CATALOG NUMBER
<input checked="" type="checkbox"/> /WG-1	KT-HBLED-WG-1-KIT /G2

STEP-DOWN TRANSFORMERS	
SUFFIX	CATALOG NUMBER
<input checked="" type="checkbox"/> /480	KTAT-250-480-277 /SF

Note: Step-down transformers cannot be ordered in conjunction with standard SJTOW cord set options (contact Keystone sales rep for available custom options if needed).

* When ordering more than one factory-installed accessory, use multiple suffixes as shown in the ordering examples above.
 Note: All accessories can also be ordered separately for field installation using just their regular Catalog Number, UPC, or Easy Code.