









MODEL NO: _____
 TYPE: _____
 PROJECT: _____
 COMMENTS: _____

INITIAL LUMEN OUTPUT
 3000 Lumens

- LAMPS OPERATED***
-  [1] 2-4 ft. T5
 -  [1] 2-8 ft. T8
 -  [2] 2-4 ft. 17W T8
 -  [1] 25W-50W Biax
 -  [1] 18W-70W 4-Pin
 -  [2] 18W-26W 4-Pin
-  Select LED Retrofit Tubes

*Refer to Lumen Reference Chart and LED Retrofit Reference Chart for list of compatible lamps.

DESCRIPTION

The **I160** from IOTA is a UL Listed fluorescent emergency ballast that allows the same fixture to be used for both normal and emergency operation. In the event of a power failure, the **I160** switches to the emergency mode and operates **one or two** of the existing lamps for **90 minutes**. The unit contains a battery, charger, and inverter circuit in a single can and is provided with 2 feet of 1/2" flex for wiring to the fixture. The unit is designed for installation next to or on top of the fixture. The **I160** can be used with most **2'-4'** lamps, with an initial output of up to **3000 lumens** for one or two lamps, and **utilizes AC output to ensure compatibility with new lamp technologies**. The unit features lamp selector leads for optimizing light output for designated lamp types. The **I160** is suitable for use in damp locations.

SPECIFICATIONS

Input Voltage	(Dual) 120/277V, 60Hz
Input Wattage	4.5 Watts
Lamps Operated	Most 2'-4' single, bipin T8 and T5, and 4-pin compact fluorescent lamps
Emergency Operation	(1) 2'-4' 17W-59W T8, (1) 8' 59W T8, (1) 2'-4' 24-95W T5, (1) 25W-50W long compact, (1) 18W-70W 4-pin compact fluorescent lamps, or (2) 2'-4' 17W T8 or 18W-26W 4-pin compacts
Initial Illumination	(1) lamp 3000 lumens (2) lamps 1500 lumens each lamp
Operating Temp	0° to 50° C
Battery	24 Hour Recharge 7-10 Year Life Expectancy
Weight	7.5 lbs.
Approval	UL and CUL 924 Listed



DIMENSIONS

16.375" x 3.0" x 3.0" (mounting center 15.875")

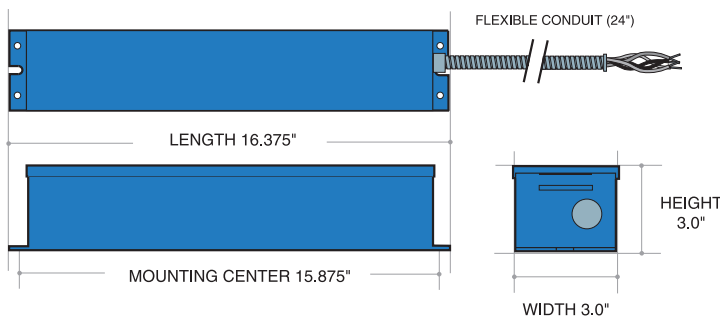

PRODUCT ADVANTAGES

- **3000 Lumen Output**
- **AC output for compatibility with Low-Mercury Content Amalgam lamps**

FEATURES

- Will cold start and operate all specified lamps
- Long life high temperature recyclable Ni-Cad battery
- Painted steel case
- Includes test switch and charge indicator accessory kit
- For use with switched or unswitched fixtures
- **5-Year Warranty**
- Rated for use in damp locations and plenum fixtures.
- Selectable lamp leads optimize light output for desired lamp type
- Meets or exceeds all NEC, IBC, and Life Safety Code Emergency Lighting Requirements
- RoHS Compliant 

FLUORESCENT

LINEAR

I160

FLUORESCENT EMERGENCY BALLAST

INITIAL LUMEN RATINGS

LAMP	1 LAMP	2 LAMPS
F17 T8	1600	2420
F32 T8	3060	
F59 T8	2835	
F95 T12	2880	
24W T5	1750	
28W T5	2965	
39W T5	2240	
47W T5	2650	
54W T5	2630	
95W T5	2935	
25W Long Compact	2300	
30W Long Compact	2300	
50W Long Compact	2300	
18W 4-Pin Compact	1125	1800
26W 4-Pin Compact	1275	1500
32W 4-Pin Compact	1550	
42W 4-Pin Compact	1750	
70W 4-Pin Compact	1725	

LED Retrofit Tube Options

This IOTA Emergency Ballast is UL Listed for emergency operation of select LED retrofit tube applications. For a complete list of acceptable LED retrofit tube options, refer to the **IOTA LED Retrofit Tube Reference Chart** at www.iotaengineering.com/IOTA-LED-Retrofit.pdf

I160 SAMPLE SPECIFICATION

Emergency lighting shall be provided by using a standard fluorescent fixture equipped with an **IOTA I160** fluorescent emergency battery pack. The **I160** shall consist of a high temperature, maintenance-free nickel cadmium battery, charger board and an electronic circuit enclosed in a 16.375" x 3.0" x 3.0" vandal-resistant painted steel case for installation adjacent to or on top of the fixture. A long-life LED charge indicator light and test switch shall be included. The fluorescent EM pack shall operate one 17w-59w T8, 24w-95w T5 (2'-4'), one 59w T8 (8'), (1) 25W-50W long compact, or 18w-70w 4-pin compact, or two 17w (2') T8 or two 18W-26W 4-pin compact lamps. The **I160** shall provide reduced illumination for a minimum of 90 minutes in the emergency mode with a total initial output of 3000 lumens, and **will operate the lamp with AC output**. The unit will feature selectable lamp leads for optimizing light output for the designated lamp type. The **I160** shall have 4.5 watts of input power and a battery capacity of 48 watt hours. The **I160** is UL Listed and meets or exceeds all NEC and Life Safety Code Emergency Lighting Requirements, and is rated for use in damp locations. The **I160** is warranted for a full five (5) years from the date of purchase.

3000 LUMEN SAMPLE SPECIFICATION

Emergency lighting shall be provided by using a standard fluorescent fixture equipped with an integral fluorescent emergency battery pack. The EM pack shall consist of a high temperature, maintenance-free nickel cadmium battery, charger board and an electronic circuit enclosed in a painted steel case for installation either adjacent to or on top of the fixture. A long-life LED charge indicator light and test switch shall be included. The fluorescent EM pack shall operate one 17w-59w T8, 24w-95w T5 (2'-4'), one 59w T8 (8'), (1) 25W-50W long compact, or 18w-70w 4-pin compact, or two 17w (2') T8 or two 18W-26W 4-pin compact lamps. The EM pack shall provide reduced illumination for a minimum of 90 minutes in the emergency mode with a total initial output of **3000 lumens**, and **will operate the lamp with AC output**. The unit will feature selectable lamp leads for optimizing light output for the designated lamp type. The unit shall have 4.5 watts of input power and a battery capacity of 48 watt hours. The EM pack must be UL Listed and meet or exceed all NEC and Life Safety Code Emergency Lighting Requirements, and rated for use in damp locations. All product shall be warranted for a full five (5) years from the date of purchase.

REMOTE MOUNTING

When battery packs are remote mounted, consult Customer Service for the maximum allowable distance between the battery pack and lamp(s).

Warranty: 5-Year Limited Warranty

Complete warranty terms located at www.acuitybrands.com/CustomerResources/Terms_and_conditions.aspx