

DESCRIPTION

The Sure-Lites SELMREC emergency light series is a UL 924 code compliant solution designed to reduce egress system cost and maintenance as well as improve reliability. It will run for a minimum of 90 minutes during a power outage and meets the requirements for both City of Chicago and New York City. The recessed mounting creates an architectural appearance that is minimally disruptive to the interior space. Key features include an LED source with egress coverage up to 60 feet, adjustable metal heads with 100 or 300 lumens/head of light output, a nickel cadmium battery as well as a stylish metal housing. The self-diagnostic capability automatically performs NFPA required testing which reduces maintenance labor. Remote capacity of 4 or 10 watts is available to power Sure-Lites SRP/ SRM remotes creating total emergency coverage of up to 129 feet.

Catalog #		Type	
Project		Date	
Comments			
Prepared by			

SPECIFICATION FEATURES

ELECTRICAL

- Dual Voltage Input
120/277 VAC, 60Hz
- 240 VAC capable with 48 hour recharge time
- Brownout circuit
- Low voltage disconnect
- Overload / Short Circuit protection
- 4.8V Battery back-up
- Minimum 90-minute runtime
- LED source with up to 300 lumens of output per head
- Eagle Eye self diagnostics standard with Laser test capability
- Remote capacity of 4 watts or 10 watts

HOUSING CONSTRUCTION

- 20 gage die formed steel
- Knockout
- Hanger bars, T-bar clips
- White or black finish

LED HEADS

- Lamp housing is made of corrosion resistant 22 gauge die formed spun aluminum
- Lamp heads adjust 80 degrees from vertical with 358 degree rotation

BATTERY

- Sealed Nickel Cadmium
- Full Recharge Time
24 hours (max.)
- 0° to 40°C (32° to 104°F)

WARRANTY

- Five year fixture warranty
- Prorated seven year battery warranty

CODE COMPLIANCE

- UL924 Listed
- Damp Location
- Life Safety NFPA 101
- NEC/OSHA
- Most State & Local Codes
- City of Chicago Compliant
- NYC Compliant
- California Energy Code Compliant



SELMREC60R4SD

SELMREC Emergency Light

**LED Emergency Light
Metal Housing
Adjustable Head
SELM
Remote Capacity**

**City of Chicago Compliant
New York City Compliant**



T20 Certified to California Title 20 Appliance Database

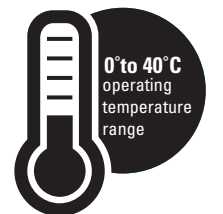

HOW TO SPECIFY

Sure-Lites Recessed LED emergency light with nickel cadmium battery, adjustable 300 Lumens/heads, sheet metal housing with self diagnostics, and four watts of remote capacity.

DIMENSIONS

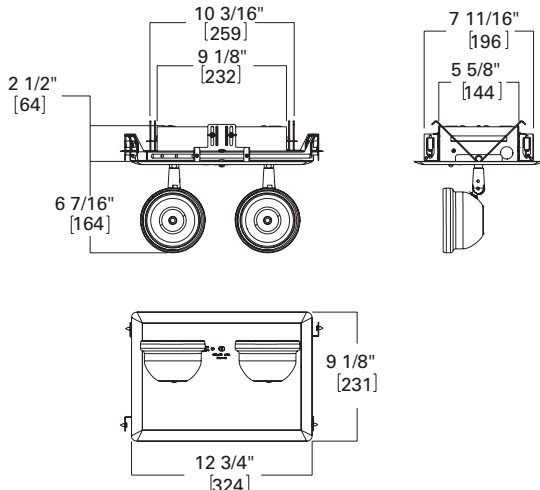

ORDERING INFORMATION

SAMPLE NUMBER:
SELMREC60R4SD

Series	Housing	Mounting	Spacing	Remote Capacity	Color	Self Diagnostics	Catalog Logic
SEL=LED Emergency Light	M=Sheet Metal	REC=Recessed	60=60 Feet	R4=4 Watts	_=white BK=black	SD=Self Diagnostics (Standard)	SELMREC60R4SD SELMREC60RBKSD

SAMPLE NUMBER:
SELMREC25R10BKSD

Series	Housing	Mounting	Spacing	Remote Capacity	Color	Self Diagnostics	Catalog Logic
SEL=LED Emergency Light	M=Sheet Metal	REC=Recessed	25=25 Feet	R10=10 Watts	_=white BK=black	SD=Self Diagnostics (Standard)	SELMREC25R10SD SELMREC25R10BKSD

ENERGY DATA

	Input Power	Current
120V	1.7W	.25A
277V	1.6W	.21A

TECHNICAL DATA

LED Heads

All-metal and formed-aluminum lampheads. The die-cast metal three dimensional swivel assembly permits approximate aiming adjustment from 80° vertical and 358° rotation. The placement is secured with a lockable pivot mounted on a rotating base ring.

Housing

The rugged 20-gauge die-formed cold rolled steel housing is finished with corrosion resistant polyester powder coat paint. Cabinet has keyhole mounting slots and knockouts in rear and side for wiring connections and has universal mounting pattern.



Laser tester

Part Number = LASER
(sold separately)

Remote Capability

The SELMREC series offers remote capability of 4 watts or 10 watts. This enables the ability to power the SureLites SRP or SRM series remotes to create an emergency system capable of egress coverage up to 125 feet. The SRP/SRM remotes are UL listed for wet locations and are rated for temperatures from - 30 C to 60 C.

Low Voltage Disconnect

The low-voltage circuitry disconnects the lighting load to protect the battery after run times in excess of the standard for the fixture. The disconnect remains in effect until normal utility power is restored preventing deep battery discharge.

Eagle Eye™ Self Diagnostics

The Eagle Eye self-diagnostic software will automatically perform all tests required by UL924, and NFPA101. The system indicates the status of the emergency light at all times using the LED indicator. A 90 minute battery power (emergency mode) simulation test will occur once every 12 months. A 30 second battery power simulation test will occur every 30 days.

Brownout Circuit

The brownout circuit on the SELMREC series emergency light monitors the flow of AC current to the unit and activates the emergency light heads when a predetermined reduction of AC power occurs.

Laser Test

The Self-Diagnostic option include a laser pointer testing capability. Activation of the photocell test button with a laser pointer will simulate loss of AC power and engage the emergency operation of the exit and emergency heads.

Warranty

The SELMREC series is backed by a five-year warranty on the fixtures and a seven year prorated battery warranty.

REMOTE CAPACITY

		SEL Series Remotes						
		SRPA	Single Head Remotes			Double Head Remotes		
		SRPA29	SRP/SRM13	SRP/SRM25	SRP/SRM30	SRP25D/ SRM25D	SRP50D/ SRM50D	SRP60D/ SRM60D
Watts Consumed		3.5	1.25	2.5	4.1	2.5	5	8.2
Catalog number	Remote Watts Available	# of SRPA29 remotes fixture will power	# of SRP/SRM13 remotes fixture will power	# of SRP/SRM25 remotes fixture will power	# of SRP/SRM30 remotes fixture will power	# of SRP25D/ SRM25D remotes fixture will power	# of SRP50D/ SRM50D remotes fixture will power	# of SRP60D/ SRM60D remotes fixture will power
SELMREC60R4SD	4	1	3	1	NA	1	NA	NA
SELMREC25R10SD	10	2	8	4	2	4	2	1



SRP



SRPD



SRM



SRMD



SRPA WHITE

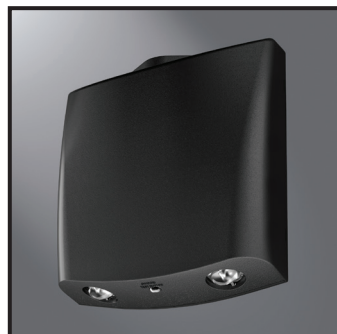

SRPA BLACK

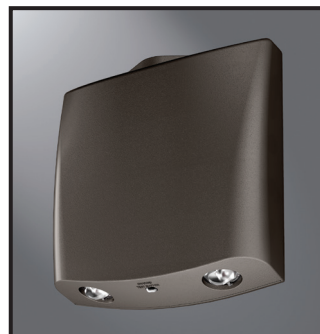

SRPA BRONZE



SRPA SILVER

PHOTOMETRY

SELMREC4SD

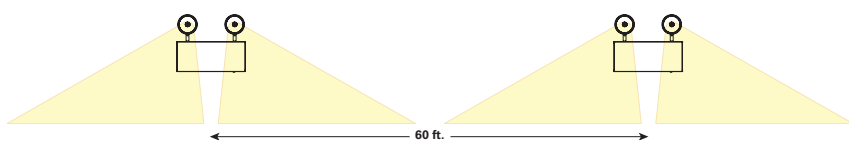
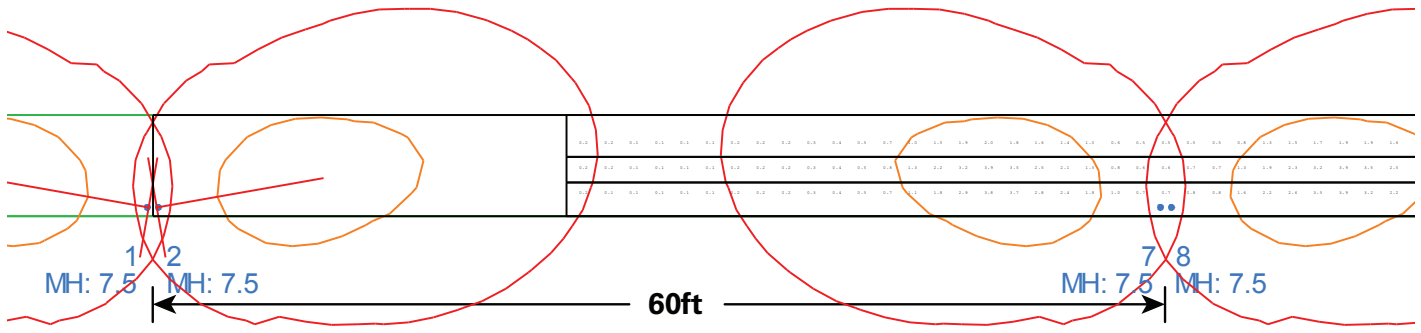

X	Y	Z	Orient	Tilt
-0.25	0.5	7.5	170	57
0.25	0.5	7.5	10	57
120.25	0.5	7.5	10	57
119.75	0.5	7.5	170	57
59.75	0.5	7.5	170	57
60.25	0.5	7.5	10	57
180.25	0.5	7.5	10	57
179.75	0.5	7.5	170	57

SELMREC25R10SD

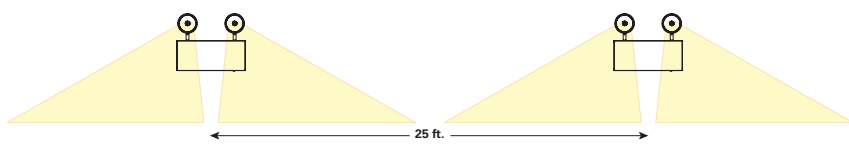
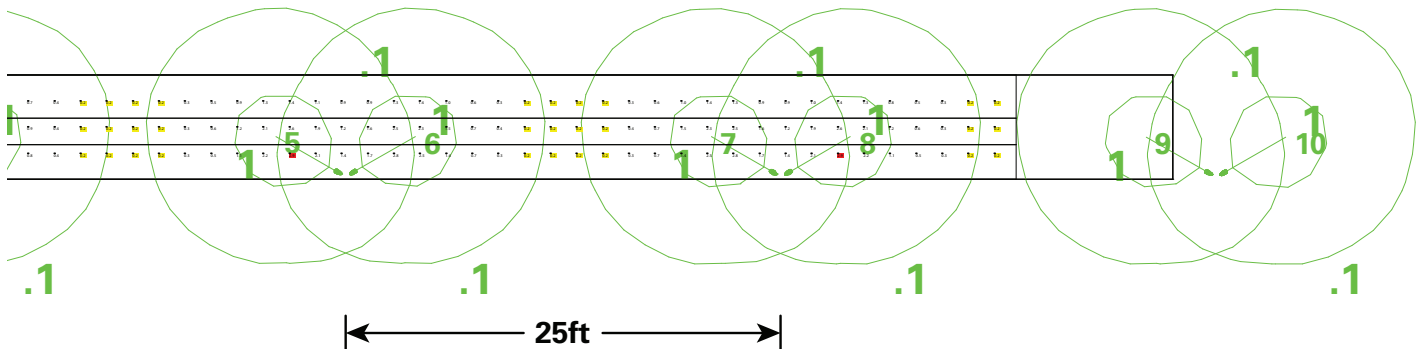

X	Y	Z	Orient	Tilt
-0.5	0.25	7.5	125	27
0.5	0.25	7.5	55	27
16.5	0.211	7.5	125	27
17.5	0.212	7.5	55	27
33.5	0.172	7.5	125	27
34.5	0.173	7.5	55	27
50.5	0.132	7.5	125	27
51.5	0.135	7.5	55	27
67.5	0.093	7.5	125	27
68.5	0.096	7.5	55	27
84.5	0.054	7.5	125	27
85.5	0.058	7.5	55	27
101.5	0.015	7.5	125	27
102.5	0.019	7.5	55	27

***The "Rule of Thumb" spacing guidelines are designed to achieve 1 foot-candle average and 0.1 foot-candle minimum with a 40:1 maximum/minimum ratio. The corridor used is 100 feet long, 9 foot ceiling with a 6 foot wide walkway and 3 foot path of egress. The reflectances are 80% ceiling, 50% walls and 20% floors. The fixture mounting height is 7.5 feet. Cooper Lighting Solutions assumes no responsibility for local requirements or specific project variables. This is a guideline to be used as a design aid, not as guarantee of any code compliance.

SELF DIAGNOSTIC TESTING OPERATIONS

The Sure-Lites Eagle Eye Self Diagnostics is continuously monitoring your emergency fixture, and will signal any failure through the 3 color indicator LED.

Initial Operation:

When the unit is first powered up it will go into a 24 hour fast charge and the indicator LED will pulse green. Once the unit has fully charged it will perform a self calibration. After self calibration, the LED will change to steady green indicating the unit is fully charged and float charging the battery to maintain readiness.

Automatic Testing:

The unit will perform a battery capacity, lamp/LED, and charge circuit test every 30 days for 30 seconds. During this time, the indicator LED will change to a steady yellow. It will perform a full battery capacity (90 minute) test once per year. During this time, the indicator LED will change to a blinking yellow.

Manual Testing:

- 10 Second "Installation" test – Press and release the test button once during fast charge (blinking green) to initiate a 10 second quick test. The sign will switch to emergency mode for 10 seconds allowing the installer to verify proper installation of the unit, and the LED indicator will turn solid yellow.
- 30 Second Test - Press and release the test button once during float charge (steady green). The indicator LED will turn steady yellow to indicate the unit is performing a 30 second test of the batteries and lamps/LEDs.
- 90 Minute Test - Press and release the test button a second time during a 30 second test (steady yellow) to change to a 90 minute test. During this test, the LED indicator will change to blinking yellow, and the circuit will perform a full battery capacity, charge circuit, and LED test.
- Canceling Test – Press and release the test button during the 90 minute test (flashing yellow) to return the fixture to its original state (fast charge or float charge)

Laser Test:

The SEL SD products are equipped with a Laser Test function that allows the unit to be manually tested without the need to physically press the test button. Shining a laser pointer in the hole marked "LASER TEST" on the bottom of the unit has the same effect as a press and release of the test button.

Clearing Failure Codes:

- A battery failure (LED two blink red) can be cleared by replacing the battery. Disconnecting the battery and AC power, or performing a full 90 minute discharge will reset the error code, however, it will return if the battery is faulty
- Charge Circuit (LED three blink red) and lamp/LED failure (LED four blink red) will clear when the unit successfully passes a manual or automatic 30 second test.

SELF DIAGNOSTIC TESTING OPERATIONS

Indicators:

- LED Off - No power to unit, emergency mode.
- LED Steady Green - Unit is fully charged and is float charging the battery to maintain readiness.
- LED Green Pulse - Unit is in a 24 hour fast charge of the battery.
- LED Two Blink Red - Battery has failed a capacity test, or the battery is disconnected. See "Clearing Failure Codes" above.
- LED Three Blink Red - Battery charge circuit has failed. See "Clearing Failure Codes" above.
- LED Four Blink Red - Lamps have burned out, or on an EXIT/Combo, 50% or more of the LEDs have failed. See "Clearing Failure Codes" above.
- LED Steady Yellow - 30 second test or 10 second quick test (Fast Charge only).
- LED Blinking Yellow - 90 minute test.

Maintenance:

None required. Replace the batteries as needed according to ambient conditions. However, we recommend that the equipment be tested regularly in accordance with local codes.

