

- Constant Current LED Driver
- Output Wattage: 40W Max.
- Universal Voltage (120V-277V~)
- CC Programmable 250-1500mA
- 0-10V Dimming
- Long Case
- Output voltage range of 10-57V~
- IP65
- U-OUT 60V

**General Specifications**

Input Voltage	120-277~, 50/60 Hz
Input Current	0.42A Max.
Input Power	50W
Power Factor	>0.9
THD	<20%
Efficiency	89% Typical@277V Full Load
Driver Type	Constant Current
Output Current	250-1500mA
Output Voltage Range	10-57V~
Output Power	40W Max.
Number of Output Channels	1 Channel
Dimming Controller Type/Dimming Range	0-10VDC / 100%-1%,0% (Figure 1)
RFI/EMI	FCC Part 15B Consumer EN55015
Output Type	LED Class 2
Potting Type / Degree of Fill	Potting As Per ASTM D36-86 / Fully Potted
Ambient Operating Temperature Range	-40°C to 60°C (-40°F to 140°F)
Max. Case Temperature	90°C (194°F)
Sound Rating	A
Input Surge Protection	Line-Neutral 4kV, Line & Neutral-Ground 6kV
Protections	Input Current Protection
	Output Short Circuit Protection
	Output Open Circuit Protection
	Output to Ground Short Protection
	Overload Protection
	Over Temperature Protection
Service Life	50,000 hours @Tc 85°C (181°F)
Approvals / Class	UL Listed, Class P, Type HL, Dry or Damp Locations
Warranty	5 years

**Figure 1**

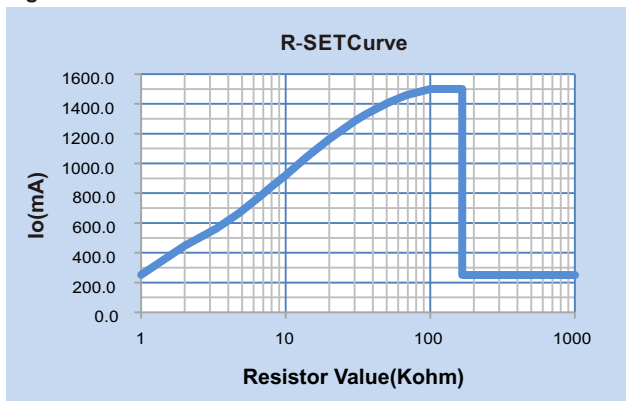

**Figure 2**

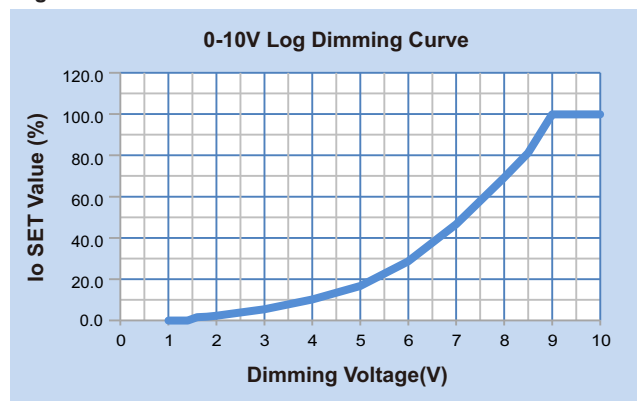

Figure 3

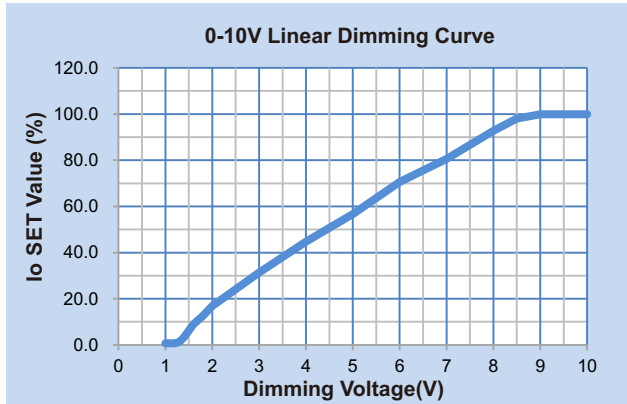

Figure 4

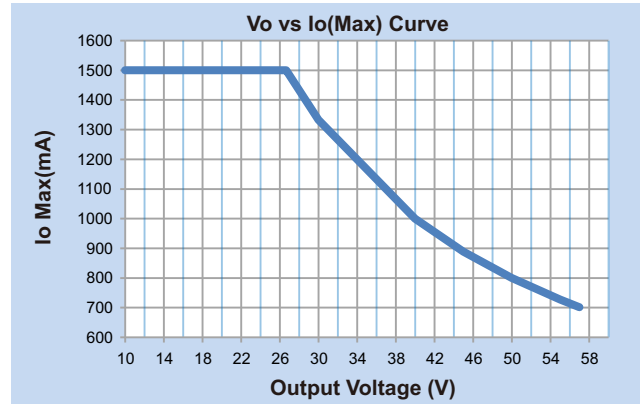

Figure 5

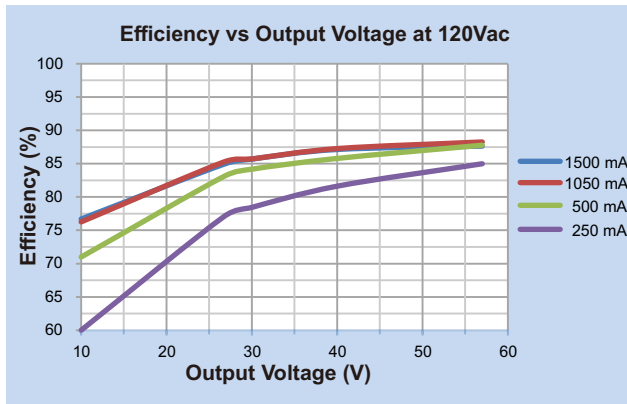

Figure 6

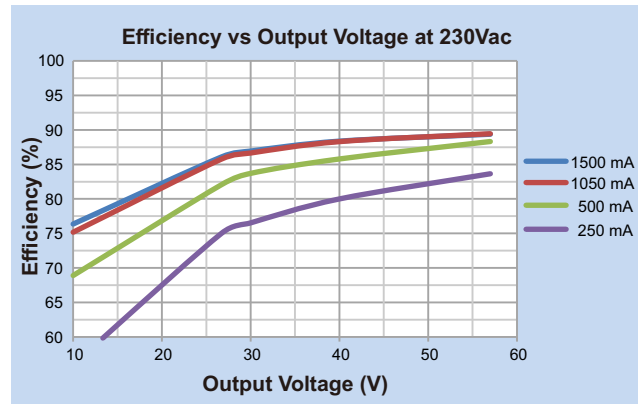

Figure 7

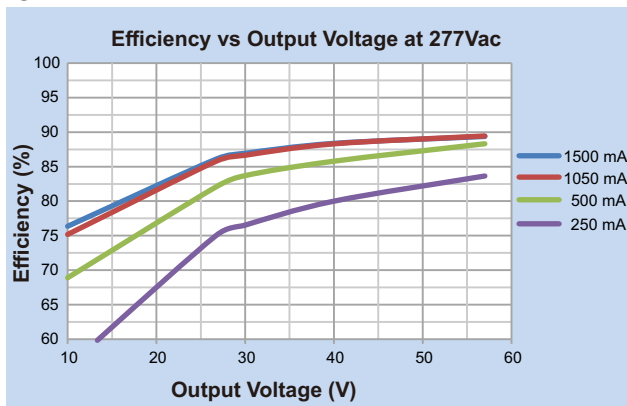

Figure 8

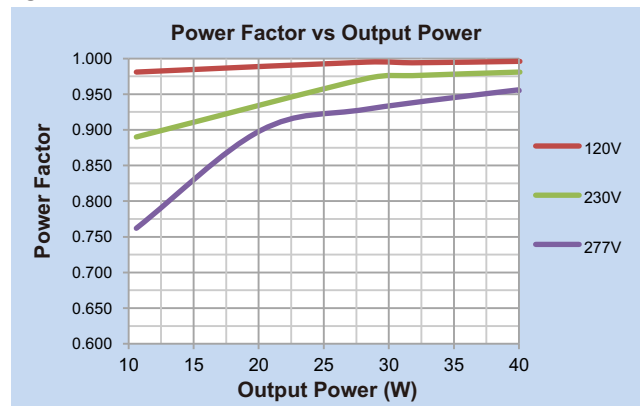

Figure 9

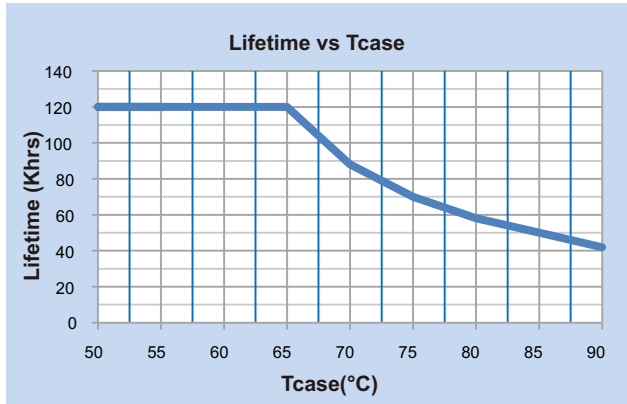

Figure 10

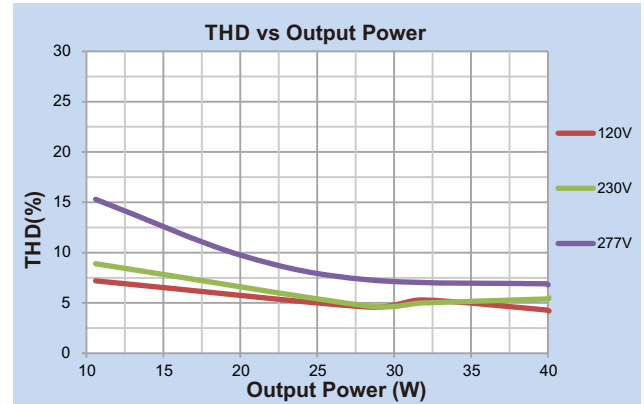

Figure 11

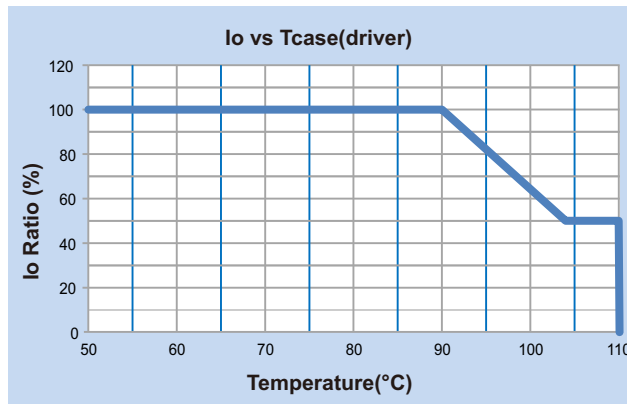
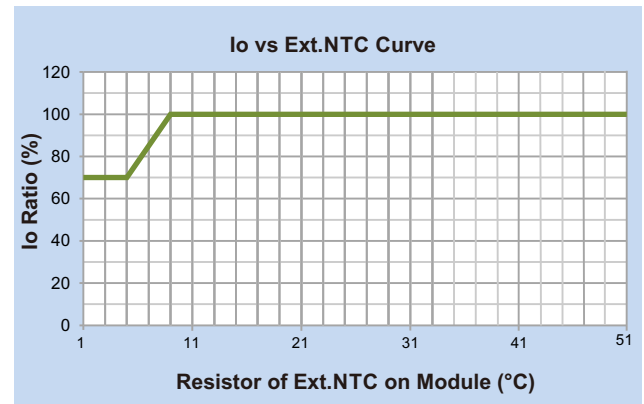

Figure 12



**Mechanical Data**

**NOTE :**

- 1.This Driver Must Be Installed By A Licensed Electrician
- 2.This Driver Must Be Grounded

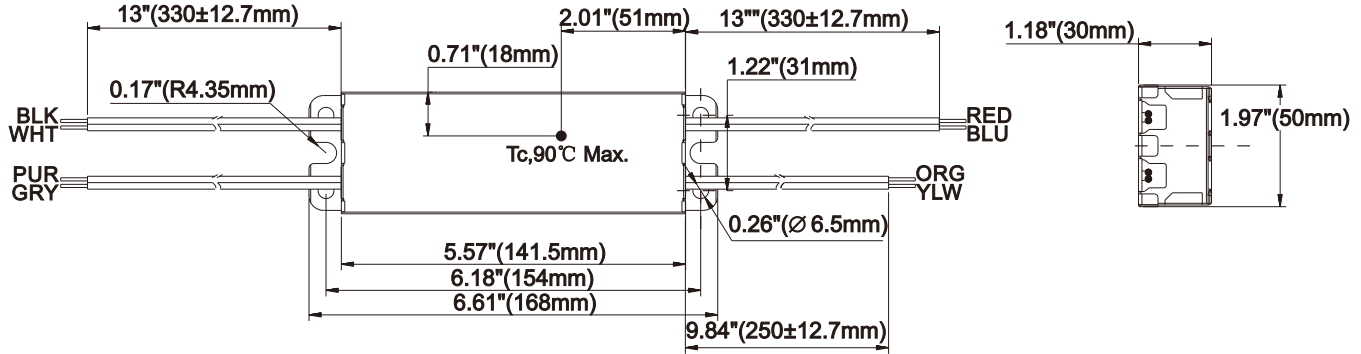

**Wiring Diagrams**

INPUT SIDE	LENGTH
BLACK	13.0" [330mm]
WHITE	13.0" [330mm]
PURPLE	13.0" [330mm]
GRAY	13.0" [330mm]

OUTPUT SIDE	LENGTH
RED	13.0" [330mm]
BLUE	13.0" [330mm]
ORANGE	9.84" [250mm]
YELLOW	9.84" [250mm]

